

1ST PRINTING - JULY 95

# SEGA

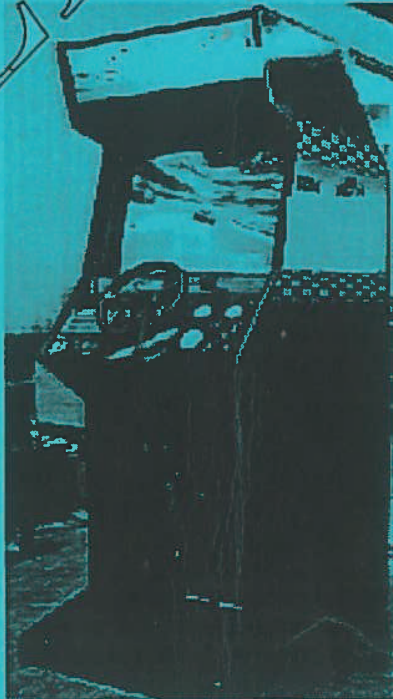

## UPRIGHT OWNER'S MANUAL



### SEGA ENTERPRISES, INC.

MANUAL NO. 4201-6150

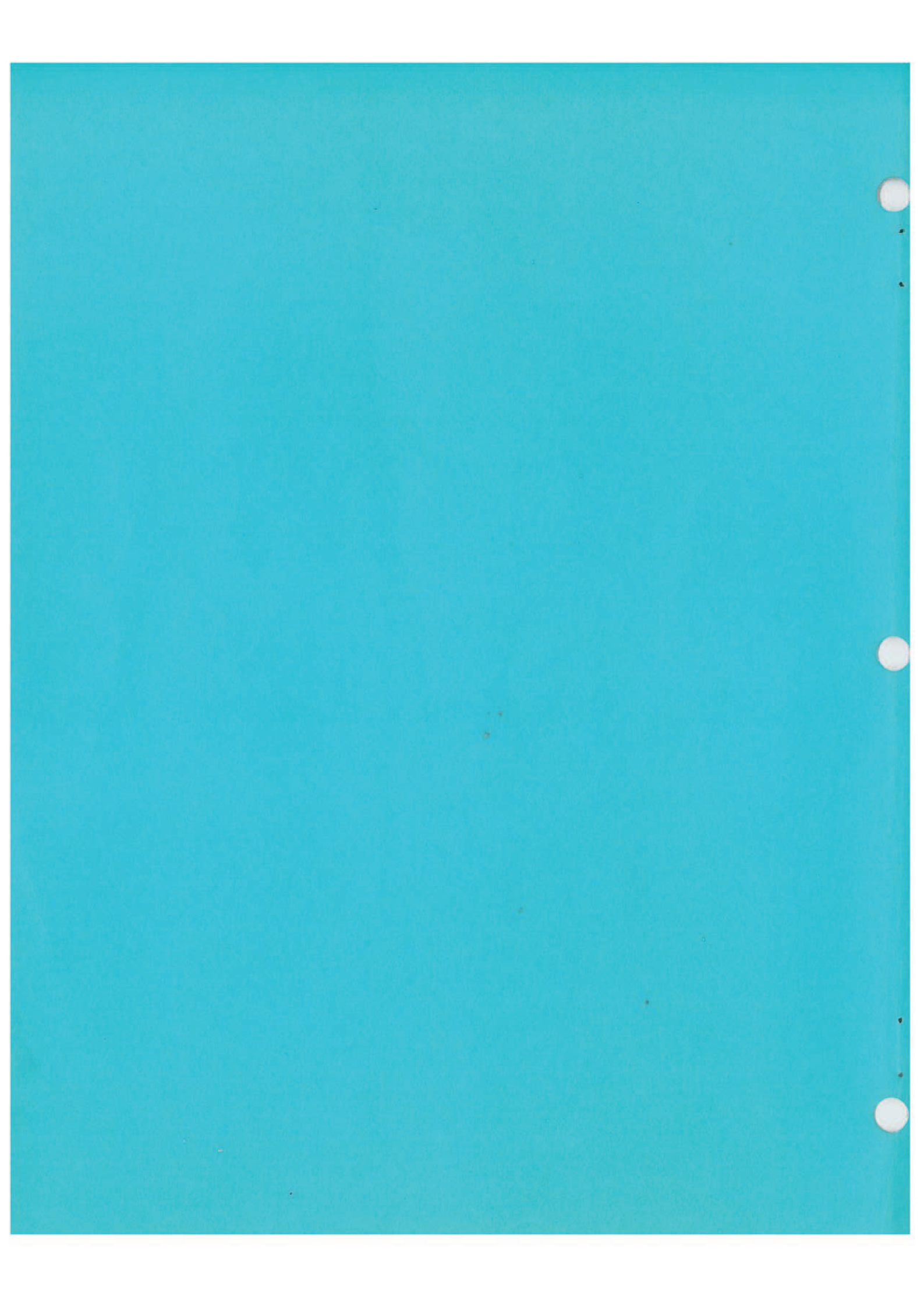

1ST PRINTING - JULY 95

# SEGA



## UPRIGHT OWNER'S MANUAL



### SEGA ENTERPRISES, INC.

MANUAL NO. 4201-6150



PRELIMINARY

## **COPYRIGHT NOTICE**

This SEGA product has a copyright notice as follows:

**© 1995 Sega Enterprises, Inc. All rights reserved.**

This signifies that this work was disclosed in 1995 and is the property of SEGA ENTERPRISES, INC.

Every effort has been made to ensure that this manual is accurate. Sega Enterprises, Inc. is not liable for any printing or clerical errors.

Specifications noted herein are subject to change without notice.

---

---

This is a preliminary version of the RALLY  
UPRIGHT manual.

Information in this manual is subject to change  
without notice.

---

---



## Table of Contents

<u>Section</u>	<u>Page</u>
List of Tables . . . . .	2
List of Figures . . . . .	3
Introduction and Specifications . . . . .	4
1. Handling Precautions . . . . .	5
2. Prevention of Counterfeiting and Conversion . . . . .	6
3. Precautions Concerning Installation Location . . . . .	7
4. Accessories . . . . .	8
5. Assembling the Machine . . . . .	9
6. How to Play . . . . .	12
7. Explanation of Test and Data Displays . . . . .	16
8. Monitor Adjustments . . . . .	31
9. Periodic Check . . . . .	32
10. Troubleshooting . . . . .	33
11. Linking Instructions . . . . .	35
12. Machine Options . . . . .	38
13. Parts Identification . . . . .	39
14. Wiring Diagram . . . . .	49
Comments on Manual . . . . .	50





## List of Tables

<u>No.</u>	<u>Title</u>	<u>Page</u>
1	Specifications . . . . .	4
2	Accessories . . . . .	8
3	Explanation of Test Modes . . . . .	15
4	Service Panel Functions . . . . .	16
5	Coin/Credit Setting . . . . .	24
6	Periodic Check and Maintenance Items . . . . .	31
7	Troubleshooting Guide . . . . .	32
8	V.R. and Start Button Assembly Part Numbers . . . . .	47
9	V.R. and Start Button Lens Cap Part Numbers . . . . .	47
10	V.R. and Start Button Legend Part Numbers . . . . .	47
11	V.R. and Start Button Bezel Assembly Part Numbers . . . . .	47

## List of Figures

<u>No.</u>	<u>Title</u>	<u>Page</u>
1	Bottom View, Leg Levelers . . . . .	9
2	Side View, Leg Levelers . . . . .	9
3	Service Panel Controls . . . . .	10
4	Control Panel Locations . . . . .	12
5	On-Screen Display Locations . . . . .	13
6	Service Panel Indicators . . . . .	16
7	Degaussing Switch Assembly . . . . .	17
8	Test Menu . . . . .	18
9	Bookkeeping - Page 1 . . . . .	19
10	Bookkeeping - Page 2 . . . . .	20
11	Game System - SINGLE Machine . . . . .	21
12	Coin Assignments . . . . .	23
13	Input Test . . . . .	25
14	Output Test . . . . .	26
15	Sound Test . . . . .	27
16	TGP Test . . . . .	28
17	Memory Test . . . . .	28
18	Backup RAM Clear . . . . .	29
19	Linking Diagram . . . . .	34
20	Game System - MASTER Machine . . . . .	35
21	Game System - SLAVE Machine(s) . . . . .	35
22	Marquee and Monitor Section . . . . .	38
23	Control Panel Section . . . . .	39
24	RALLY Upright Graphics . . . . .	40
25	Over/Under Coin Door and Dual Pedal Section . . . . .	40
26	Internal Assemblies . . . . .	41
27	Shifter Assembly . . . . .	42
28	Dual Pedal Assembly . . . . .	43
29	Over/Under Coin Door Assembly . . . . .	44
30	Steering Wheel Assembly . . . . .	45
31	V.R. and Start Button Assembly . . . . .	46
32	Wiring Diagram . . . . .	48

TABLE 1: SPECIFICATIONS

<u>DIMENSIONS</u>	<u>SHIPPING</u>	<u>NET</u>
WIDTH	: 28.5 in.	25.5 in.
DEPTH	: 42 in.	39 in.
HEIGHT	: 71.5 in.	71 in.
WEIGHT	: 385 lbs.	375 lbs.
POWER, MAXIMUM CURRENT	: 360 Watts, 3 amps	
MONITOR	: 26 Inch Color,	Medium Resolution

## INTRODUCTION OF THE OWNER'S MANUAL

---

SEGA ENTERPRISES, LTD., supported by its high technology semiconductors, microprocessors, etc. and a wealth of experience, has for more than 30 years been supplying various innovative and popular game machines to the world market. This Owner's Manual is intended to provide detailed descriptions together with all the necessary servicing control, spare parts, etc. related to the RALLY UPRIGHT, a new SEGA product.

This manual is intended for those who have knowledge of electricity and technical expertise, especially in ICs, CRTs, microprocessors, etc. Carefully read this manual to acquire sufficient knowledge before working on the machine. Should there be a malfunction non-technical personnel should under no circumstances touch the interior system. Should such a case arise, contact our Main Office or the closest branch office listed:

SEGA ENTERPRISES, INC. (U.S.A.)

Customer Service

41533 Industrial Drive

Fremont, CA 94538 USA

Phone (415) 802-1750

FAX: (415) 802-1754

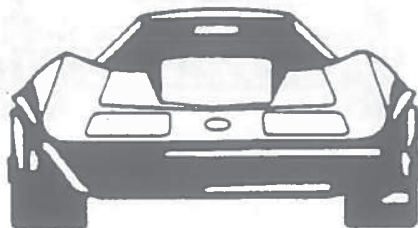

## 1. HANDLING PRECAUTIONS

---

When installing or inspecting the machine, be aware of the following items. Pay attention to be sure that the players can enjoy the game safely.

- Be sure to turn the power off before working on the machine.
- Do not insert or pull out the plug quickly.
- Make sure that the power cord and grounding wire are not exposed during transportation. Make sure that grounding connections are made safely at the installation position where specified.
- Do not use any fuse that does not meet the specified rating.
- Make complete connections for the IC board and other connections. Insufficient connections are very dangerous.
- The operating (ambient) temperature range is 5°C to 40°C.
- When cleaning the monitor glass, use a soft cloth. Do not apply chemicals such as benzine, thinner, etc.

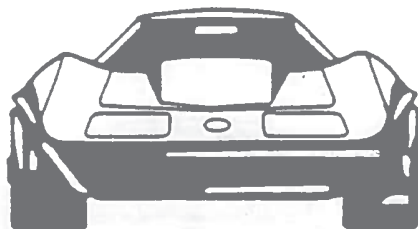

## 2. PREVENTION OF COUNTERFEITING AND CONVERSION

---

### LABELING

To prevent counterfeits and conversions, the following labels are put on all SEGA products. When handling such goods, be sure to confirm the labels. They are used to prevent illegal acts such as the unauthorized copying of merchandise or by converting, selling or using products or printed circuit boards.

#### ORIGINAL SEAL

The following seal is put on all machines manufactured by SEGA.

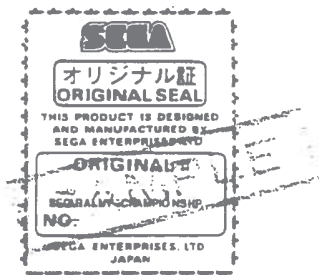

#### LICENSE SEAL

The following seal is put on all SEGA kits, such as printed circuit boards.



### COPYRIGHT NOTICE

This SEGA product has a copyright notice as follows:

© SEGA 1995

This signifies that this work was disclosed in 1995 and is the property of SEGA ENTERPRISES, INC.

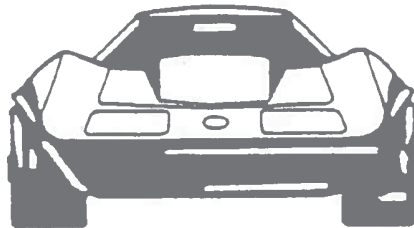

### 3. PRECAUTIONS CONCERNING INSTALLATION LOCATION

---

The Rally Upright is an indoor game machine. Absolutely do not install it outside. Even indoors, to ensure proper usage, avoid installing in any of the places mentioned below. Follow all of the installation instructions and precautions when installing the machine.

#### LOCATION PRECAUTIONS:

- Places subject to rain or water leakage, or condensation due to humidity.
- In the proximity of an indoor swimming pool and/or shower.
- Places subject to direct sunlight.
- Places subject to heat sources from heating units, etc., or hot air.
- In the vicinity of highly inflammable/volatile chemicals or hazardous matter
- On sloped surfaces.
- In the vicinity of anti-disaster facilities such as fire exits and fire extinguishers.
- Places subject to any type of violent impact.
- Dusty places.

#### INSTALLATION PRECAUTIONS:

- Do not insert more than one electrical plug into the power plug socket.
- The per unit standard voltage/amperage is 120V/10A.
- Use of extension cords should be avoided. If you must use ensure the extension cords are rated at 15A or higher.
- For transporting the machine into the location's building, the minimum necessary dimensions of the opening (doors, etc.) are 36 in. (W) x 80 in. (H).
- For operation of the machine, the minimum installation dimensions are 30 in. (W) x 50 in. (D).

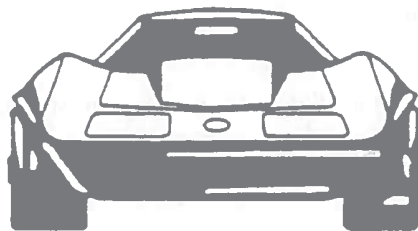

## 4. ACCESSORIES

---

When transporting the machine, make sure that the parts listed in Table 2 are supplied.

TABLE 2: ACCESSORIES

PART NAME	QTY.
Key - Coin Mech Door	2
Key - Cash Box (Behind Coin Mech Door)	2
Key - Rear Service Door (Behind Coin Mech Door)	2
Owner's Manual - Daytona Upright	1
Linking Fiber Optic Cable - (In Cash Box)	1

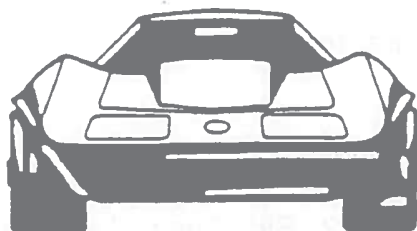

## 5. ASSEMBLING THE MACHINE

### **WARNING!**

Make sure that all four (4) of the leg levelers are in contact with the floor. If they are not, the cabinet may move and cause an accident.

#### Step 1. Leg Leveler Adjustment

This machine has four leg levelers (See Fig. 1). When the installation position has been determined, adjust the leg levelers so that they all contact the floor and the machine is level.

1. Move the machine to the installation position.
2. Adjust all leg levelers by hand so they make contact with the floor. Continue to adjust levelers until machine is level.
3. After adjustments are complete, fasten the leg leveler nut upward and secure the height of the leg leveler. (See Fig. 2.)
4. Since this machine is a heavy object, its leg levelers should be retracted when moving the machine over the floor

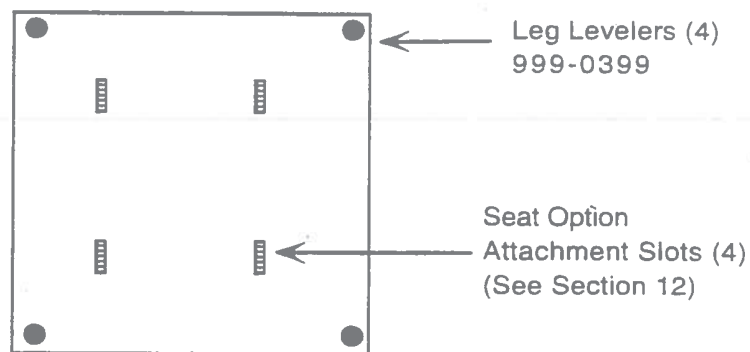

FIGURE 1: Bottom View, Leg Levelers

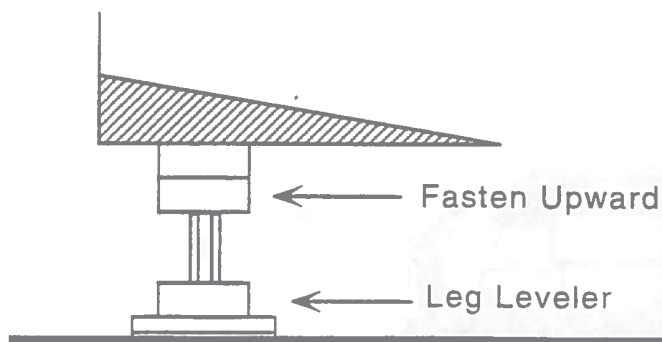

FIGURE 2: Side View, Leg Levelers



## 2. Turning the Power On

Toggling the AC Unit's Main Switch, located in the lower-left rear of the cabinet, will cause the machine to power up and run a POWER ON check.

## 3. Assembly Check

Open the Coin Mech Door and press the TEST switch on the Service Panel (See Figure 3) to place the machine in TEST mode. See Section 7 for further details on the Test mode. **NOTE 1** is located on the rear side of the Service Panel.

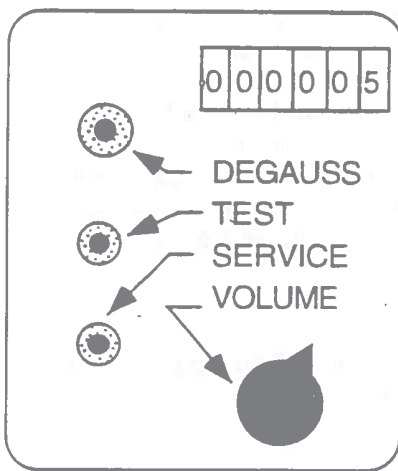

### NOTE 1:

#### WARNING

For continued protection against risk of shock, replace degaussing switch assembly with exact configuration as originally provided by the mfg.

Figure 3: Service Panel Controls

In TEST mode, perform the following four (4) tests:

### (1) MEMORY TEST

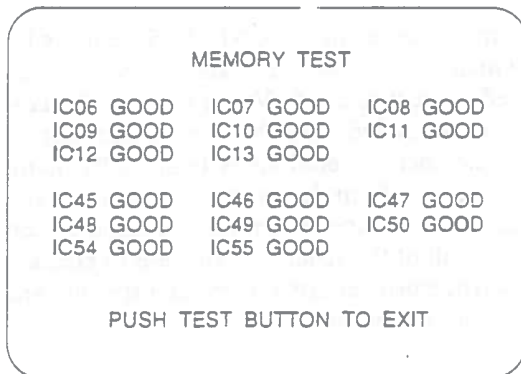

Selecting the MEMORY TEST on the test mode menu screen causes the on-board memory to be tested automatically. The game board is satisfactory if the display beside each IC No. shows GOOD.

## (2) INPUT TEST

INPUT TEST	
CHUTE1	: OFF
CHUTE2	: OFF
SHIFT1	: OFF
SHIFT2	: OFF
SHIFT3	: OFF
SHIFT4	: OFF
VR	: OFF
START	: OFF
TEST SW	: OFF
SERVICE	: OFF
HANDLE	: XXH
ACCEL	: XXH
BRAKE	: XXH

PUSH TEST BUTTON TO EXIT

Selecting the INPUT TEST on the test mode menu screen causes the screen (on which each switch and V. R. are tested) to be displayed. Press each switch. For the coin switch test, insert a coin from the coin inlet with the coin chute door being open. If the display beside each switch indicates "ON," the switch and wiring connections are satisfactory.

Ascertain the display of V. R. value for the steering wheel and accelerator & brake. If the V. R. values are not satisfactory, refer to Sections 9 & 10.

## (3) C.R.T TEST

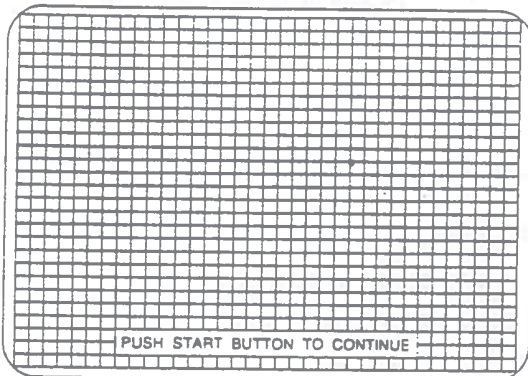

PUSH START BUTTON TO CONTINUE

In the TEST mode menu, selecting OUTPUT TEST allows the screen (on which the projector is tested) to be displayed. Although the projector adjustments have been made at the time of shipment from the factory, color deviation, etc., may occur due to the affection caused by geomagnetism, the location building's steel frames and other game machines in the periphery. By watching the test mode screen, make judgment as to whether an adjustment is needed. If it is necessary, adjust the projector by referring to Section 13.

## (3) OUTPUT TEST

OUTPUT TEST

START  
VR

PUSH TEST BUTTON TO EXIT

In the output test mode, carry out lamp test to ascertain that each lamp lights up satisfactorily.

## (4) SOUND TEST

SOUND TEST	
Voice	:
Effect	:
B.G.M	:
>EXIT	:

SELECT BY SERVICE BUTTON  
AND PUSH TEST BUTTON

In the TEST mode, selecting SOUND TEST causes the screen (on which sound related BD and wiring connections are tested) to be displayed. Voice and BGM (background music) are emitted from the tweeter speakers (a round type), one each on both sides (right/left) of the control panel and also from the front speakers (a square type), one each on both sides (right/left). Sound effects are emitted from all of the speakers. Be sure to check if the sound is satisfactorily emitted from each speaker and the sound volume is appropriate.

Perform the above inspections also at the time of monthly inspection.

## 6. HOW TO PLAY

---

The following explanations apply to the case where the RALLY UPRIGHT is operating in the SINGLE mode. In cases where multiple machines are *linked*, see the RALLY TWIN manual.

Refer to Figure 4 for Control Panel control locations.

- (1) Take a ride in the machine. The seat position can be adjusted forward and backward. For adjustments, pull the lever which is positioned on the lower left-hand side (facing the projector screen) of the seat .
- (2) Insert a coin(s). Inserting a coin(s) for one play causes the Game Select mode to appear on the screen. Up to 9 credits can be registered at any one time, and the credits are displayed only in this mode and not thereafter.
- (3) The left-hand side of the Game Select mode refers to the Championship mode and the right-hand side, the Practice mode. Turn the steering wheel to select the Championship mode or Practice mode and make the selection by stepping on the Accelerator.

### • WHEN PLAYING IN THE CHAMPIONSHIP MODE:

- (1) The Car Select mode appears on the screen. There are 4 different combinations to choose from (2 different cars, Celica and Delta and 2 different Shifts, AUTO and MANUAL). Turn the steering wheel to select the desired combination and make the selection by stepping on the Accelerator.
- (2) After the above selection procedure, the game starts.
- (3) The on-screen upper left-hand side, the upper middle downwards, the upper right-hand side and the lower left-hand side respectively indicates Total Time & Lap Time, the achievement meter / rear mirror / remaining time / Navigation Icon, the player's present position, and Tachometer / Shift / Speed.

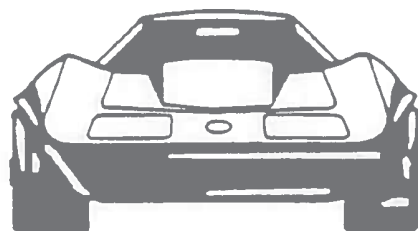

(4) After the game is started, the allotted time decreases. Passing a checkpoint within the time limit allows the game to continue with the previous remaining time added to the time limit up to the next checkpoint. If you fail to pass a checkpoint within the time limit with remaining time (if any) added, the game will be over.

(5) Finishing 2 laps, one lap, and also one lap respectively for "DESERT" (Easy), "FOREST" (Middle) and "MOUNTAIN" (Expert) enables you to proceed to the next course. The player whose results are superior is allowed to proceed to a hyper course. The lap setting can be changed (refer to Section 8).

(6) The player with the best results can register his name. Turn the steering wheel to choose the alphabetical letters and step on the Accelerator to make the selection. The name will be displayed on the DEMO screen.

#### • WHEN PLAYING IN THE PRACTICE MODE:

(1) The Course Select mode showing "DESERT," "FOREST," and "MOUNTAIN" sequentially, starting from the left appears on the screen. Turn the steering wheel to select the cat selection by stepping on the Accelerator.

(2) The Car Select screen appears. Turn the steering wheel to choose one from 4 combinations (2 different cars and 2 kinds of shifts) and make the selection by stepping on the Accelerator.

(3) After the above car selection, the game starts.

(4) The screen display during game is the same as in the Championship mode.

(5) The relationship between the remaining time and clearing a checkpoint after the game start is also the same as in the Championship mode. The game will be over if you fail to pass the checkpoint before the remaining time becomes zero.

(6) When you finish 3 laps, 2 laps and 2 laps respectively for "DESERT," "FOREST" and "MOUNTAIN," the game will be over. The lap setting can be changed.

(7) During play, "DRIVER'S EYE" and "VIEW FROM BEHIND" perspective can be alternated by using the View Change SW.

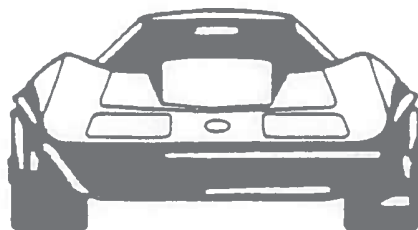

(8) The steering wheel reacts to surface status and car movements. The seat vibrates depending on surface status, etc. When one game is finished, if any credit(s) sufficient for playing another game remains, the Game Select mode appears.

## PLAYING TECHNIQUE

(1) It is recommended that you choose **AUTOMATIC** if you are not familiar with the game. Find out the best way to pass the corners by referring to navigation icons.

(2) When **MANUAL SHIFT** is chosen, refer to the Tachometer for shifting. **SHIFTING UP** when the indicator indicates a point before the red zone allows the acceleration to be made in the most efficient manner.

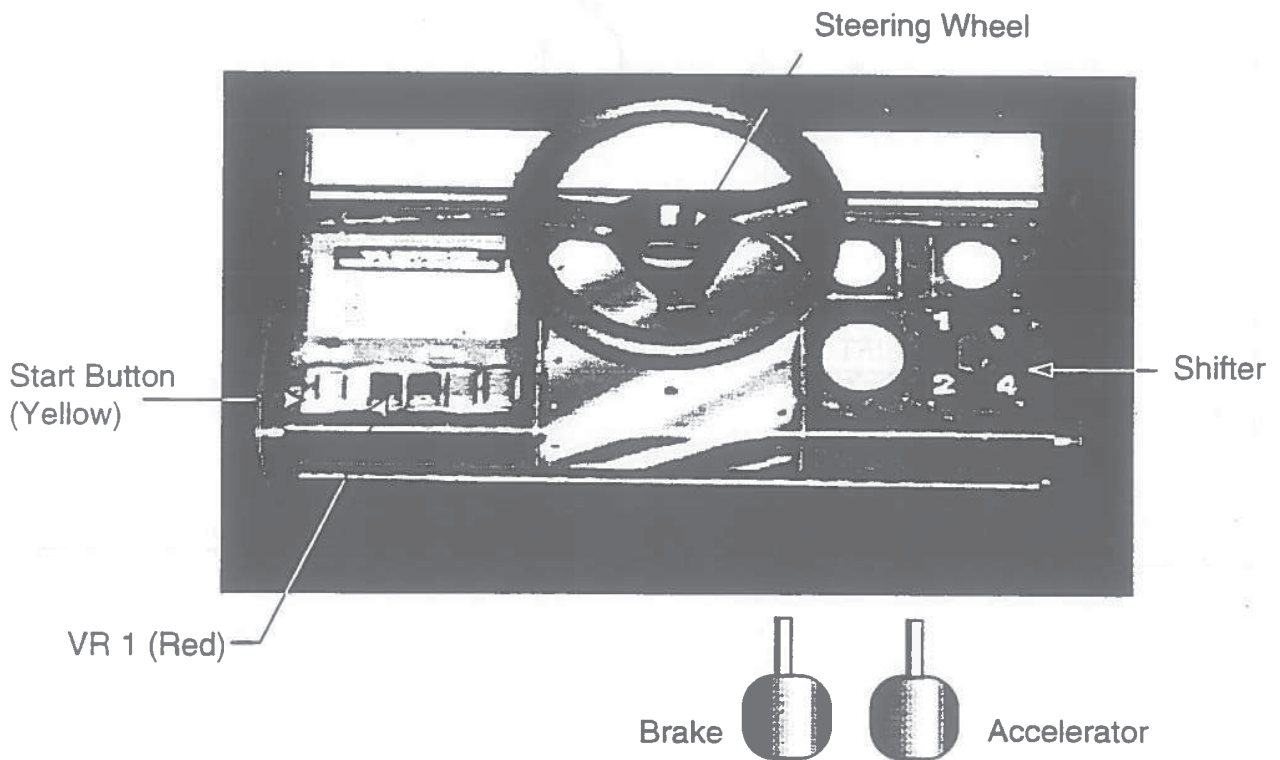
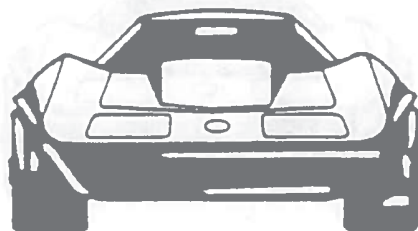

Figure 4: Control Panel Locations



REMAINING TIME

ACHIEVEMENT METER

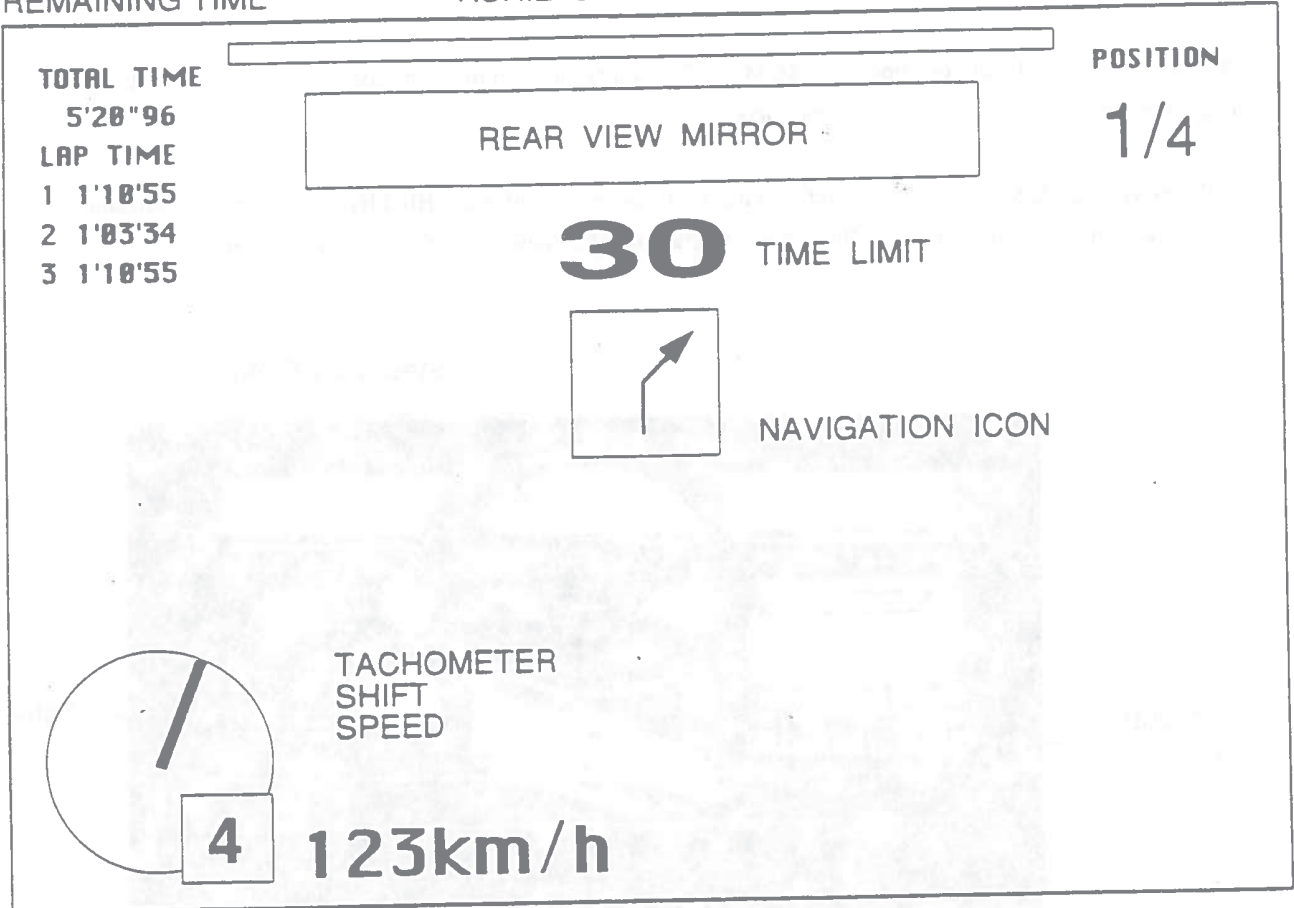
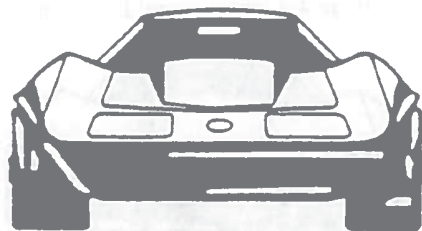

Figure 5: On-Screen Display Locations



## 7. EXPLANATION OF TEST AND DATA DISPLAYS

### 1. Test Mode Scheduling

The machine should be tested whenever it is installed, when cash is collected, monthly, or whenever the machine is not operating correctly. This is done by pressing the Test switch on the Service Panel. The tests and modes listed in Table 3 should be used as applicable.

TABLE 3: EXPLANATION OF TEST MODES

ITEMS	DESCRIPTION
INSTALLATION OF MACHINE	When the machine is installed, perform the following: 1. Check to see that each setting is as per standard setting made at the time of shipment. 2. In the INPUT TEST mode, check each SW and VR. 3. In the OUTPUT TEST mode, check each of lamps. 4. In the SELF-TEST mode, check ICs on the IC Board.
MEMORY	Choose MEMORY TEST in the MENU mode to allow the memory test to be performed. In this test, PROGRAM RAMs, ROMs, and ICs on the IC Board are checked.
PERIODIC SERVICING	Periodically perform the following: 1. MEMORY TEST 2. Ascertain each setting. 3. In the INPUT TEST mode, test the CONTROL device. 4. In the OUTPUT TEST mode, check each of lamps.
CONTROL SYSTEM	1. In the INPUT TEST mode, check each SW and VR. 2. Adjust or replace each SW and VR. 3. If the problem can not be solved yet, check the CONTROL's moves.
MONITOR	1. In the MONITOR ADJUSTMENT mode, check to see if the MONITOR adjustment is appropriately made. 2. Demagnetize monitor using DEGAUSS switch on Service Panel.
IC BOARD	1. MEMORY TEST 2. In the SOUND TEST mode, check the sound related ROMs.
DATA CHECK	Check such data as game play time and histogram to adjust the difficulty level, etc.

## 2. Service Panel

The Service Panel is located behind the Coin Mech Door. See Figure 6. The functions of each control on the Service Unit are as shown in Table 4.

TABLE 4: SERVICE PANEL FUNCTIONS

CONTROL	FUNCTION
TEST Switch	For the use of the TEST switch , see sections 3 - 13.
SERVICE Switch	Gives credits without registering on the coin meter.
VOLUME Knob	Adjusts the volume of the monitor's speakers. Volume increases when knob is turned clockwise.
DEGAUSSING Switch	Eliminates color unevenness from the monitor screen. See Figure 7 for degaussing switch assembly diagram.

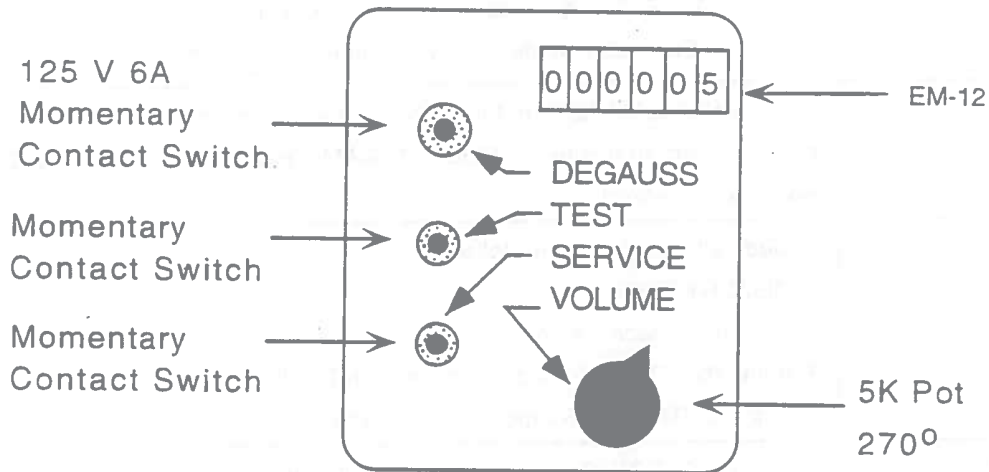

**NOTE 1:**

**WARNING**

For continued protection against risk of shock, replace degaussing switch assembly with exact configuration as originally provided by the mfg.

Figure 6: Service Panel Indicators



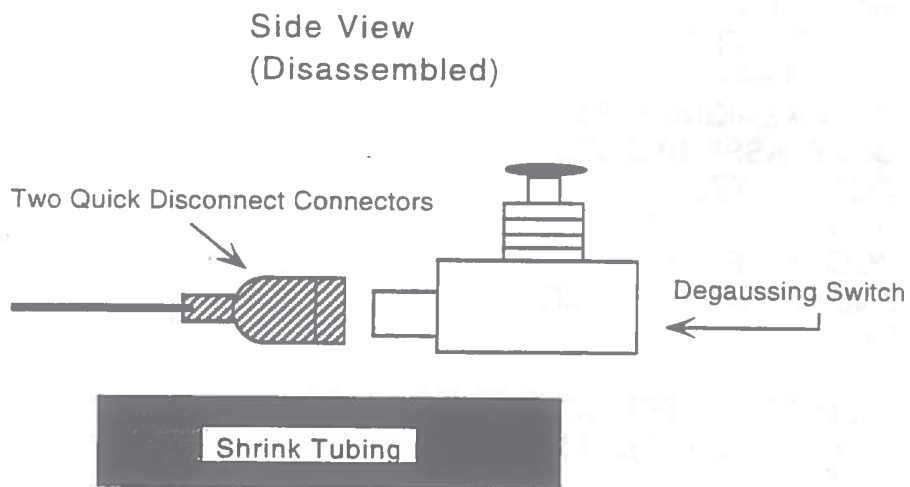
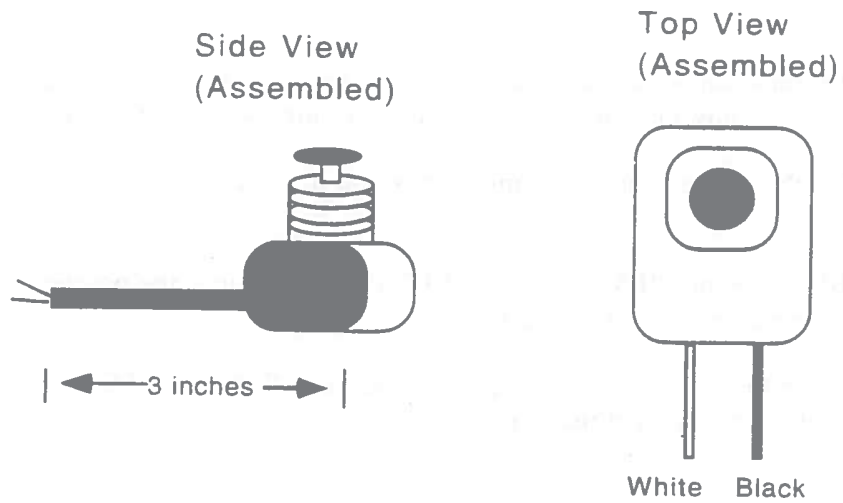

Figure 7: Degaussing Switch Assembly

### 3. Test Mode

The Test Menu allows the functioning of each part of the Cabinet to be checked, the monitor to be adjusted, and the coins and game related various settings to be performed.

- Press the TEST BUTTON to cause the following Test Menu to be displayed on the monitor. (FIG. 8.2)
- Press the SERVICE BUTTON or VIEW CHANGE BUTTON (VR) until the pointer ">" is moved to the desired item to make a selection.
- Bring the pointer ">" to the desired item and press either the TEST BUTTON or START BUTTON to cause the selected item's test to start.

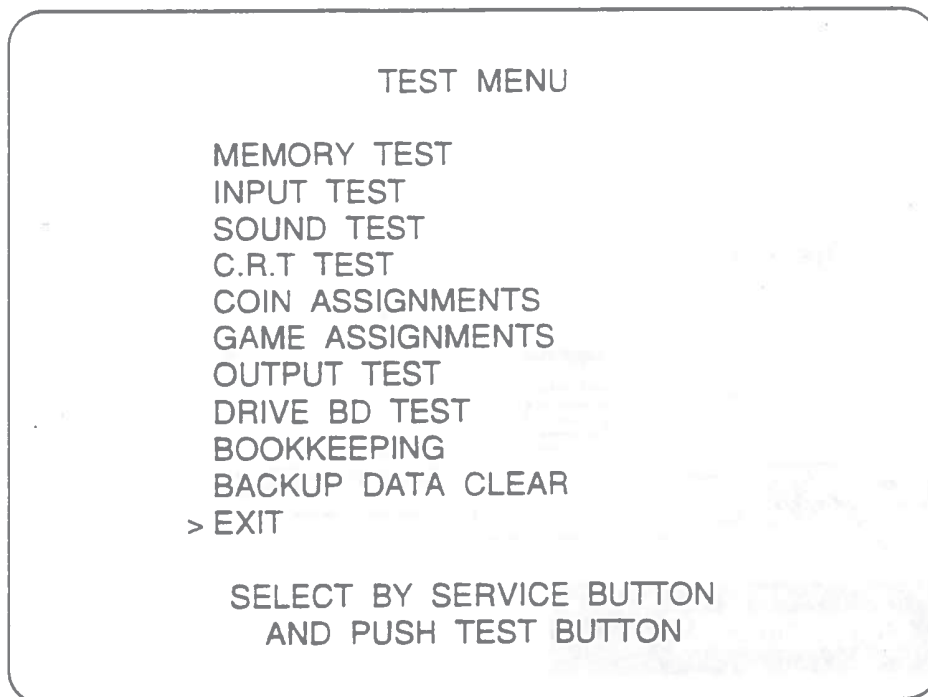

FIG. 8.2 TEST MENU

- After the test is complete, move ">" to "EXIT" and press the TEST BUTTON or START BUTTON to return to the Game Mode.

#### 4. Memory Test

The MEMORY TEST mode is for checking the on-BD memory IC functioning. "GOOD" is displayed for normal ICs and "BAD" is displayed for abnormal ICs.

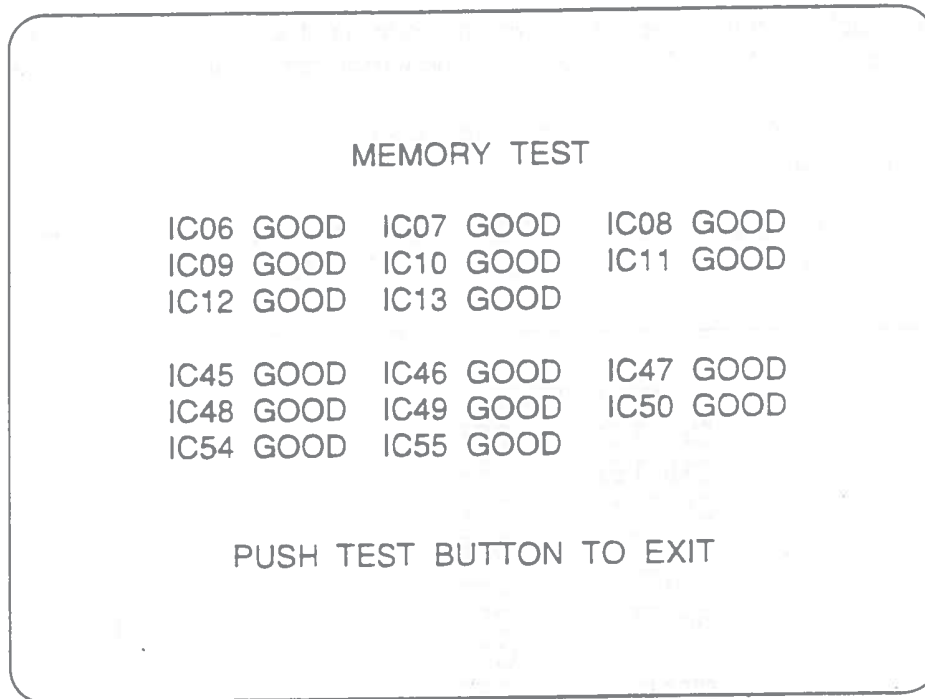
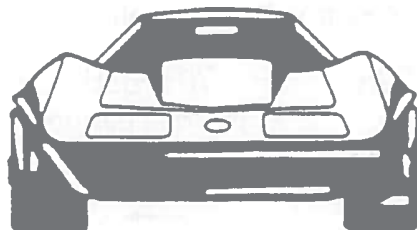

FIG. 8. 3 MEMORY TEST

- When the test is completed, if the results are shown as above, it is satisfactory.
- It takes approximately thirty seconds to complete the test. If the TEST exceeds thirty seconds, the board may have malfunctioned.
- After finishing the test, pressing the TEST BUTTON or START BUTTON to return to MENU mode.



## 5. Input Test

When INPUT TEST is selected, the monitor will show the following, allowing you to watch the status of each switch and the value of each V. R. of the CONTROL PANEL.

On this screen, periodically check the status of each switch & V. R.

- By pressing each switch, if the display on the right-hand side of the name of each switch changes to ON from OFF, the SW and the wiring connections are satisfactory.
- To check CHUTE 1 & CHUTE 2 coin switches, open the COIN CHUTE DOOR and insert a coin(s) in the slot.
- To return to the MENU mode, press the TEST BUTTON or simultaneously press the START BUTTON & VIEW CHANGE BUTTON (VR).

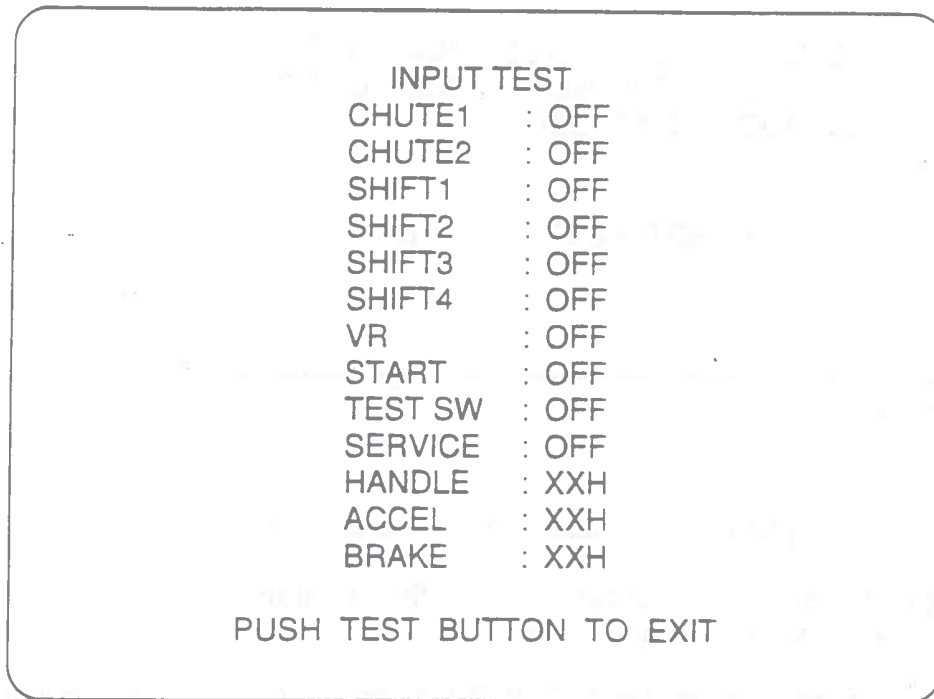

FIG. 8. 4 INPUT TEST

The appropriate values of each V. R. are as follows:

HANDLE:	Under 2DH left	← 7D~83H → (Centering position)	Over D3H right
ACCEL:	Under 30H	→	Over C0H
BRAKE:	Under 30H (the pedal released)	→	Over C0H (the pedal stepped)

## 6. Sound Test

Choosing SOUND TEST causes the following mode to appear on the screen. This allows the desired sound (BGM, announcement and sound effects) to be chosen and heard. Enables the SOUND BD, AMP BD and each speaker to be checked.

Press the SERVICE BUTTON or VIEW CHANGE BUTTON to bring the pointer ">" to the desired test item. Pressing the TEST BUTTON or START BUTTON allows the selected sound test to be performed.

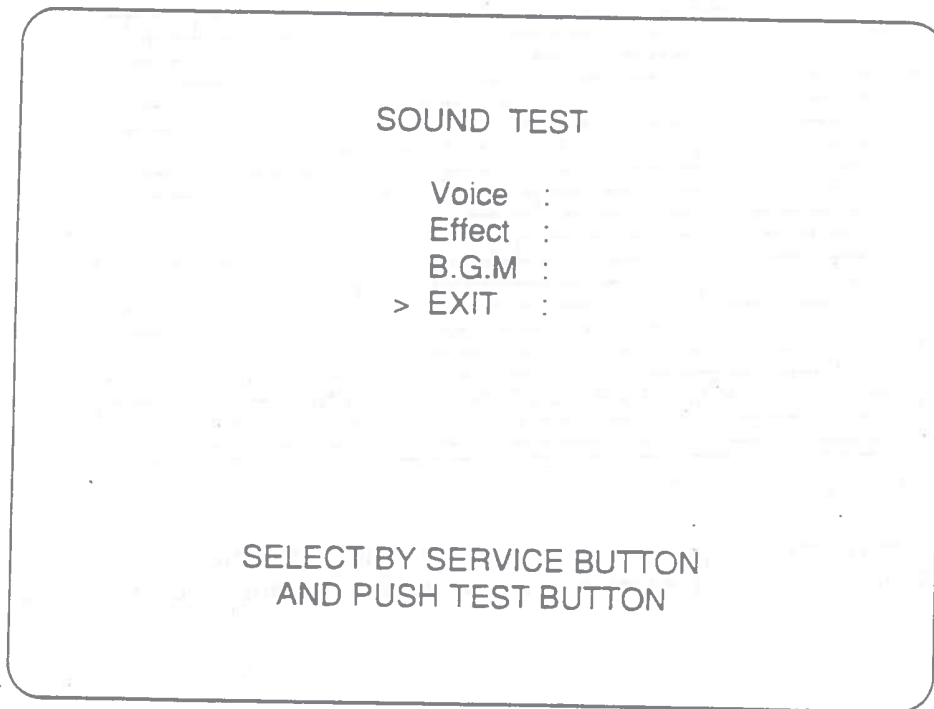

FIG. 8. 5 SOUND TEST

- Voice      Voice of announcement & navigation.
- Effect     Sound effects during game.
- B.G.M     Background music during game.
- EXIT      Causes the menu mode to return on to the screen.

## 7.C.R.T Test

Choose C. R. T. TEST to cause the following screen (upper) for monitor adjustment to appear.

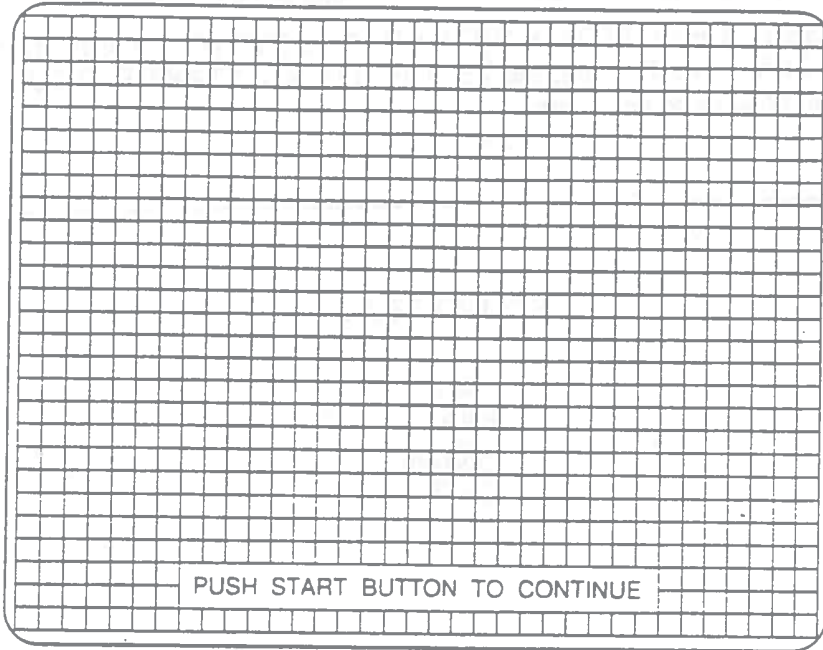

FIG. 8. 6a C. R. T. TEST

In the above screen as per FIG. 8.6 a, adjust the monitor to make sure that the crosshatch lines do not go beyond the screen size and crosshatch distortion does not occur.

Press the TEST button or START button to have the following color bar screen appear. The C. R. T. TEST as shown in FIG. 8.6 b allows for monitor color checking. Each of the R (red), G (green) and B (blue) and white is darkest at the left-hand end and becomes brighter towards the right-hand end.

Press the TEST button or START button to have the MENU return to the screen.

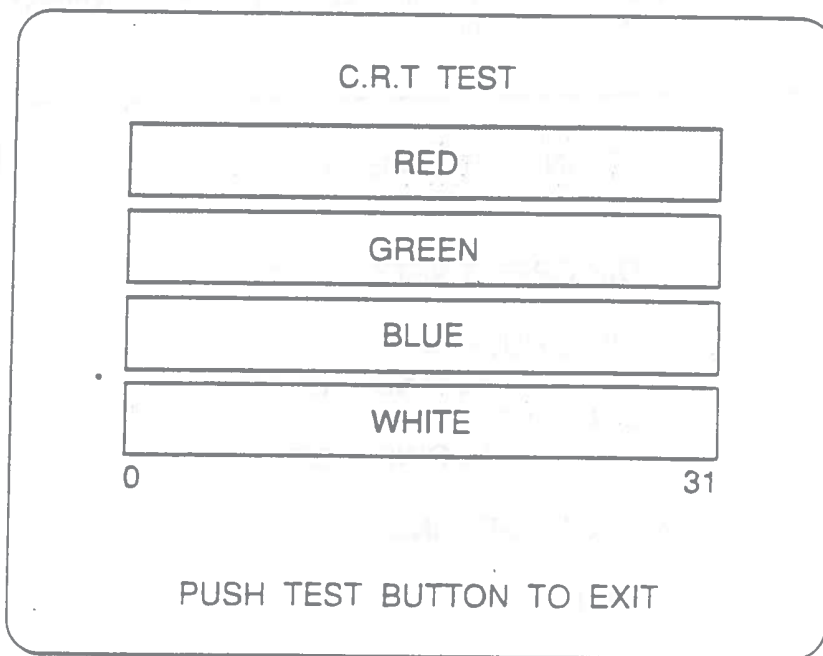

FIG. 8. 6b C. R. T. TEST

## 8. Coin Assignment

The "COIN ASSIGNMENTS" mode permits you to set the start number of credits, as well as the basic numbers of coins and credits. This mode expresses "how many coins correspond to how many credits."

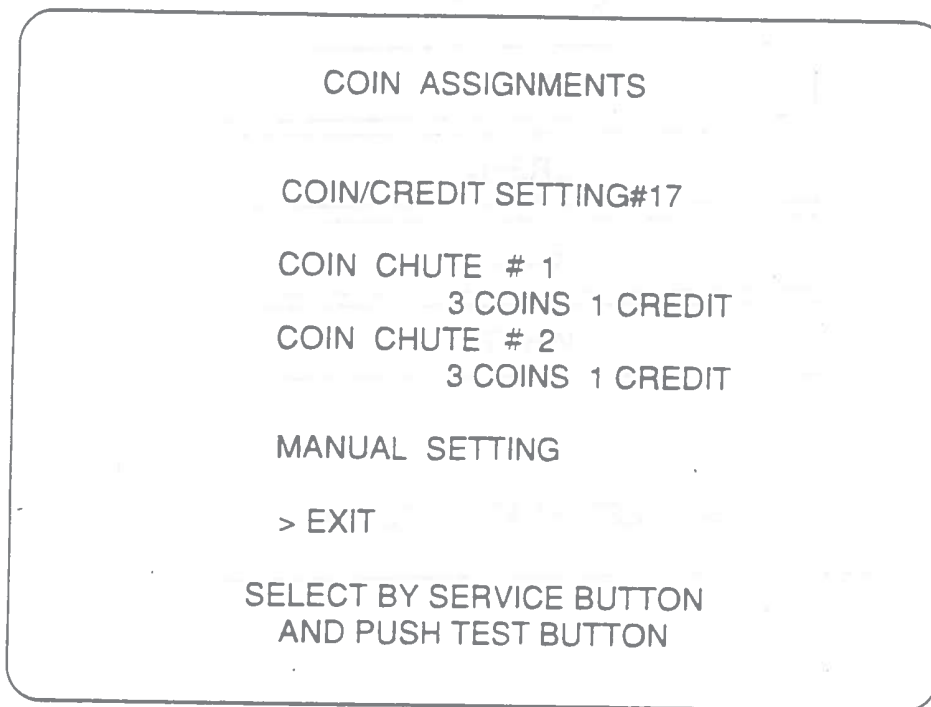

FIG. 8. 7a COIN ASSIGNMENTS

- **COIN/CREDIT SETTING** "How many coins correspond to how many credits." In this machine, selection as per Table 8.2 is possible.
- **MANUAL SETTING** Allows for finer settings.

### SETTING CHANGE PROCEDURE

- ① Press the **SERVICE** button or **VIEW CHANGE** button to move the arrow ( > ) to the desired setting change item.
- ② Press the **TEST** button or **START** button to make a setting change selection.
- ③ Move the arrow to **EXIT** and press **TEST** button or **START** button to return to the **MENU** mode.



TABLE 5: COIN/CREDIT SETTING (COIN CHUTE COMMON TYPE)

NAME OF SETTING	COIN CHUTE 1		COIN CHUTE 2	
SETTING #1	1 COIN	1 CREDIT	1 COIN	1 CREDIT
SETTING #2	1 COIN	1 CREDIT	1 COIN	2 CREDITS
SETTING #3	1 COIN	1 CREDIT	1 COIN	3 CREDITS
SETTING #4	1 COIN	1 CREDIT	1 COIN	4 CREDITS
SETTING #5	1 COIN	1 CREDIT	1 COIN	5 CREDITS
SETTING #6	1 COIN	2 CREDITS	1 COIN	2 CREDITS
SETTING #7	1 COIN	2 CREDITS	1 COIN	5 CREDITS
SETTING #8	1 COIN	3 CREDITS	1 COIN	3 CREDITS
SETTING #9	1 COIN	4 CREDITS	1 COIN	4 CREDITS
SETTING #10	1 COIN	5 CREDITS	1 COIN	5 CREDITS
SETTING #11	1 COIN	6 CREDITS	1 COIN	6 CREDITS
SETTING #12	2 COINS	1 CREDIT	2 COINS	1 CREDIT
SETTING #13	2 COINS	1 CREDIT	1 COIN	1 CREDIT
SETTING #14	2 COINS	1 CREDIT	1 COIN	2 CREDITS
SETTING #15	1 COIN	1 CREDIT	1 COIN	1 CREDIT
	2 COINS	3 CREDITS	2 COINS	3 CREDITS
SETTING #16	1 COIN	1 CREDIT	1 COIN	3 CREDITS
	2 COINS	3 CREDITS		
SETTING #17	3 COINS	1 CREDIT	3 COINS	3 CREDITS
SETTING #18	4 COINS	1 CREDIT	4 COINS	1 CREDIT
SETTING #19	1 COIN	1 CREDIT	1 COIN	1 CREDIT
	2 COINS	2 CREDITS	2 COINS	2 CREDITS
	3 COINS	3 CREDITS	3 COINS	3 CREDITS
	4 COINS	5 CREDITS	4 COINS	5 CREDITS
SETTING #20	1 COIN	1 CREDIT	1 COIN	5 CREDITS
	2 COINS	2 CREDITS		
	3 COINS	3 CREDITS		
	4 COINS	5 CREDITS		
SETTING #21	3 COINS	1 CREDIT	1 COIN	2 CREDITS
	5 COINS	2 CREDITS		
SETTING #22	2 COINS	1 CREDIT	2 COINS	1 CREDIT
	4 COINS	2 CREDITS	4 COINS	2 CREDITS
	5 COINS	3 CREDITS	5 COINS	3 CREDITS
SETTING #23	2 COINS	1 CREDIT	1 COIN	3 CREDITS
	4 COINS	2 CREDITS		
	5 COINS	3 CREDITS		

TABLE 5: COIN/CREDIT SETTINGS (cont.)

SETTING #24	1 COIN	1 CREDIT	1 COIN	1 CREDIT
	2 COINS	2 CREDITS	2 COINS	2 CREDITS
	3 COINS	3 CREDITS	3 COINS	3 CREDITS
	4 COINS	4 CREDITS	4 COINS	4 CREDITS
	5 COINS	6 CREDITS	5 COINS	6 CREDITS
SETTING #25	1 COIN	1 CREDIT	1 COIN	6 CREDITS
	2 COINS	2 CREDITS		
	3 COINS	3 CREDITS		
	4 COINS	4 CREDITS		
	5 COINS	6 CREDITS		
SETTING #26	FREE PLAY		FREE PLAY	

## MANUAL SETTING

**COIN ASSIGNMENTS  
MANUAL SETTING**

COIN TO CREDIT 3 COINS 1 CREDIT

BONUS ADDER NO BONUS ADDER

COIN CHUTE #1 MULTIPLIER 1 COIN COUNTS AS 1 COIN  
 COIN 1 2 3 4 5 6 7 8 9  
 CREDIT 0 1/3 0 2/3 1 1 1/3 1 2/3 2 2 1/3 2 2/3 3

COIN CHUTE #2 MULTIPLIER 1 COIN COUNTS AS 1 COIN  
 COIN 1 2 3 4 5 6 7 8 9  
 CREDIT 0 1/3 0 2/3 1 1 1/3 1 2/3 2 2 1/3 2 2/3 3

> EXIT

**SELECT BY SERVICE BUTTON  
AND PUSH TEST BUTTON**

FIG. 8. 7b COIN ASSIGNMENTS

- COIN TO CREDIT Determines COIN/CREDIT setting.
- BONUS ADDER This sets how many COINS should be inserted to obtain one SERVICE COIN.
- COIN CHUTE #X MULTIPLIER This sets how many tokens one COIN represents.

TABLE 6: MANUAL SETTINGS: COIN TO CREDIT

COIN TO CREDIT	1 COIN	1 CREDIT
	2 COINS	1 CREDIT
	3 COINS	1 CREDIT
	4 COINS	1 CREDIT
	5 COINS	1 CREDIT
	6 COINS	1 CREDIT
	7 COINS	1 CREDIT
	8 COINS	1 CREDIT
	9 COINS	1 CREDIT

TABLE 7: MANUAL SETTINGS: BONUS ADDER

BONUS ADDER	NO BONUS ADDER
	2 COINS GIVE 1 EXTRA COIN
	3 COINS GIVE 1 EXTRA COIN
	4 COINS GIVE 1 EXTRA COIN
	5 COINS GIVE 1 EXTRA COIN
	6 COINS GIVE 1 EXTRA COIN
	7 COINS GIVE 1 EXTRA COIN
	8 COINS GIVE 1 EXTRA COIN
	9 COINS GIVE 1 EXTRA COIN

TABLE 8: MANUAL SETTINGS: COIN CHUTE #1 MULTIPLIER

COIN CHUTE MULTIPLIER	1 COIN COUNTS AS 1 COIN
	1 COIN COUNTS AS 2 COINS
	1 COIN COUNTS AS 3 COINS
	1 COIN COUNTS AS 4 COINS
	1 COIN COUNTS AS 5 COINS
	1 COIN COUNTS AS 6 COINS
	1 COIN COUNTS AS 7 COINS
	1 COIN COUNTS AS 8 COINS
	1 COIN COUNTS AS 9 COINS

9. Game Assignments Selecting the GAME SYSTEM in the menu mode causes the present game settings to be displayed and also the game setting changes can be made. Each item displays the following content. Settings at the time of shipment are as follows:

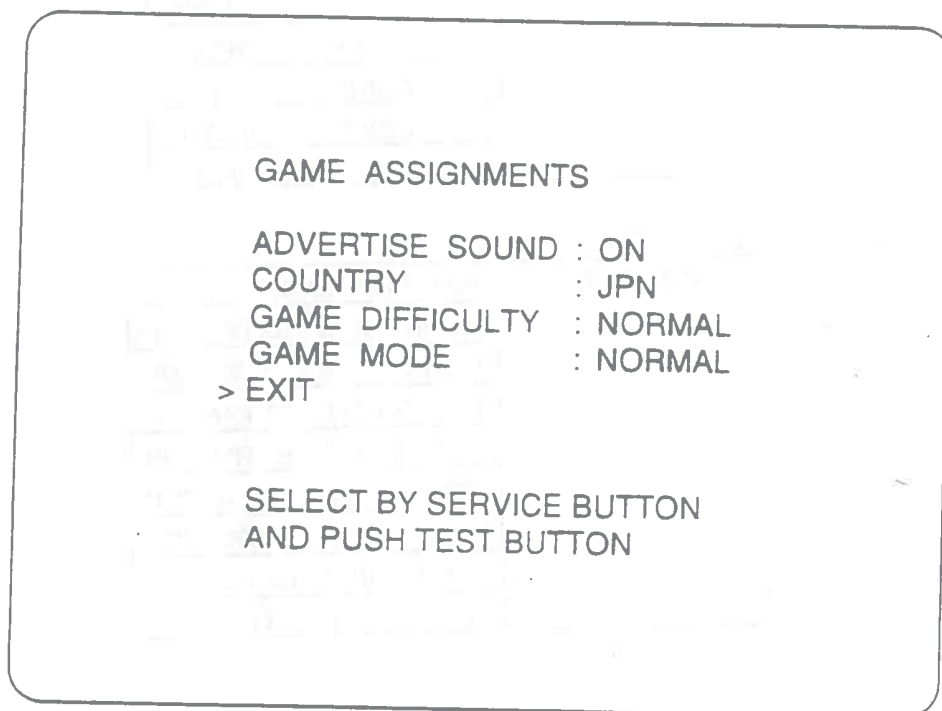

FIG. 8. 8 GAME ASSIGNMENTS

- **ADVERTISE SOUND** Advertisement sound during standby.  
No sound is produced with "OFF." Standard setting is "OFF."
- **COUNTRY** Message language ( select USA for the U. S. A. , and EXPORT for other countries)
- **GAME DIFFICULTY** The game difficulty is classified into 4 different categories from EASY to HARDEST. Standard setting is "NORMAL."
- **GAME MODE** Selection of laps from among NORMAL, SHORT, LONG, and LONGEST.

#### SETTING CHANGE PROCEDURE

- ① Press the SERVICE button or VIEW CHANGE button to move the arrow ( > ) to the desired setting change item.
- ② Press the TEST button or START button to make a setting change selection.
- ③ Move the arrow to EXIT and press TEST button or START button to return to the MENU mode.

## 10. Output Test

Choose OUTPUT TEST to have the following screen appear. Entering this mode allows the status of each lamp to be checked. In this test, periodically check the status of each lamp.

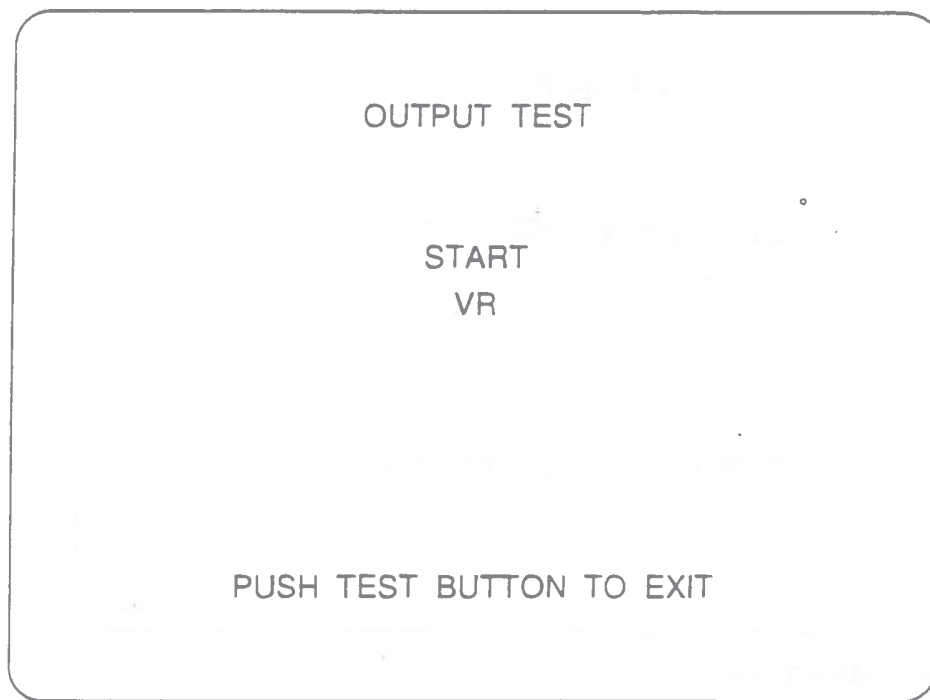

FIG. 8.9 OUTPUT TEST

Press the TEST button or the START button to return to the MENU mode.

## 11. Drive Board Test

Choosing DRIVE BD TEST allows the strength of steering wheel reaction to be adjusted.

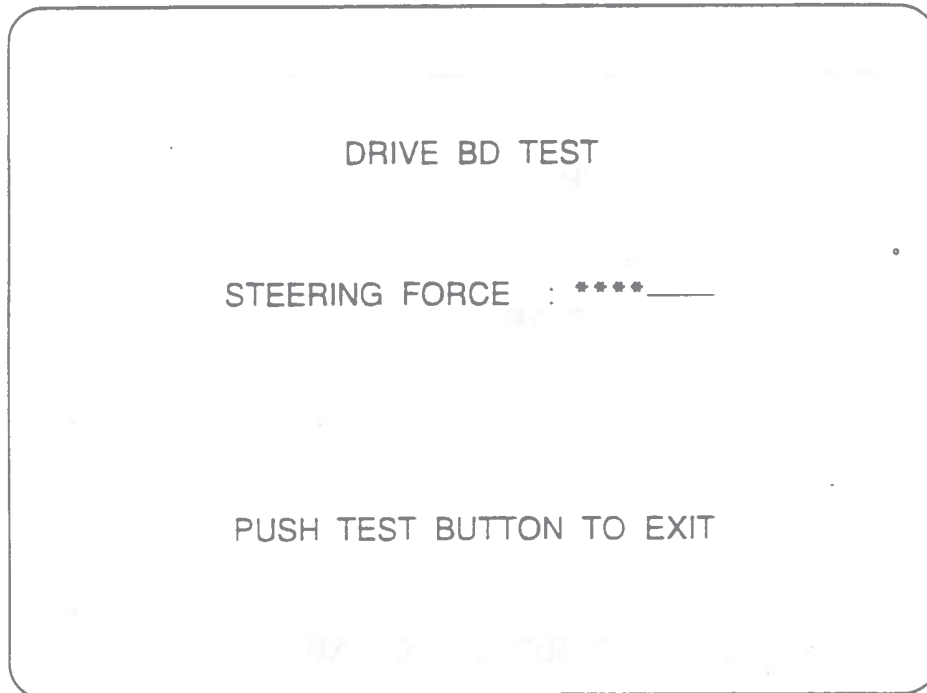

FIG. 8. 10a DRIVE BD TEST

The strength of steering wheel reaction can be adjusted in 8 steps by using the SERVICE button or VIEW CHANGE button.

The steering wheel operates as per the designated setting. Press the TEST button or START button to return to the MENU mode.

## DIP SW SETTING TABLE

### CAUTION!

- Make sure that DIP SW Nos. 4 ~ 8 are set to OFF.
- When changing DIP SW setting, ensure that the power is OFF.

The strength of steering wheel reaction can also be adjusted via on-DRIVE BD DIP SW setting. The DRIVE BD is mounted on the ASSY ELEC. Refer to 17-1 when changing the settings.

### DIP SW SETTING

NOTE: The shaded portion refers to the setting at the time of shipment.

1	2	3	FUNCTION
OFF	OFF	OFF	Light
ON	OFF	OFF	↑
OFF	ON	OFF	
ON	ON	OFF	↓
OFF	OFF	ON	
ON	OFF	ON	↓
ON	ON	ON	

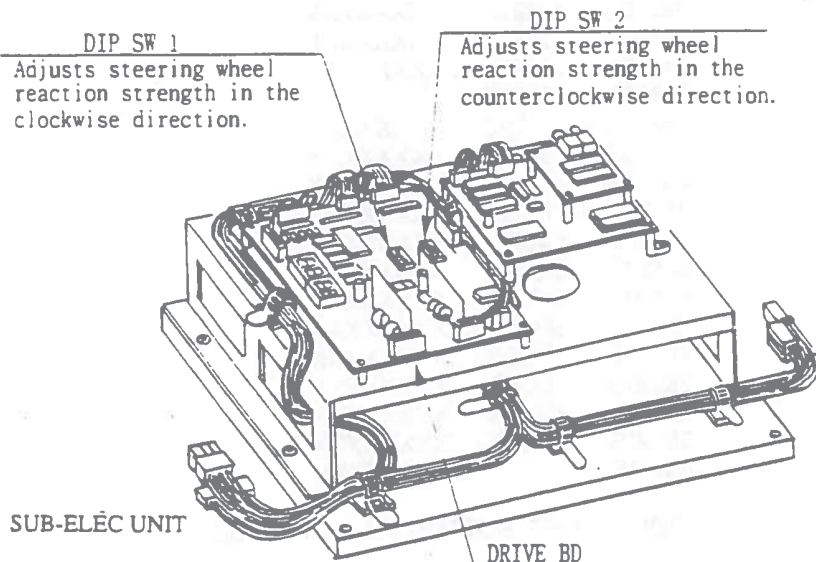

FIG. 8. 10b SUB-ELÉC UNIT

## DRIVE BD ERROR DISPLAY

When malfunctioning occurs in the DRIVE BD, testing will not be performed even if DRIVE BD TEST is selected. In this case, the error No. will be displayed by the 7-SEG display on the DRIVE BD.

Also, when a POWER-ON CHECK ERROR occurs, the 7-SEG. display data repeatedly flashes. First check the handle mecha's V. R., the motor, clutch, etc.

## 12. Bookkeeping

Selecting the BOOKKEEPING in the menu mode displays the bookkeeping data up to the present on the following 2 pages.

Press the TEST button again to proceed to the next page.

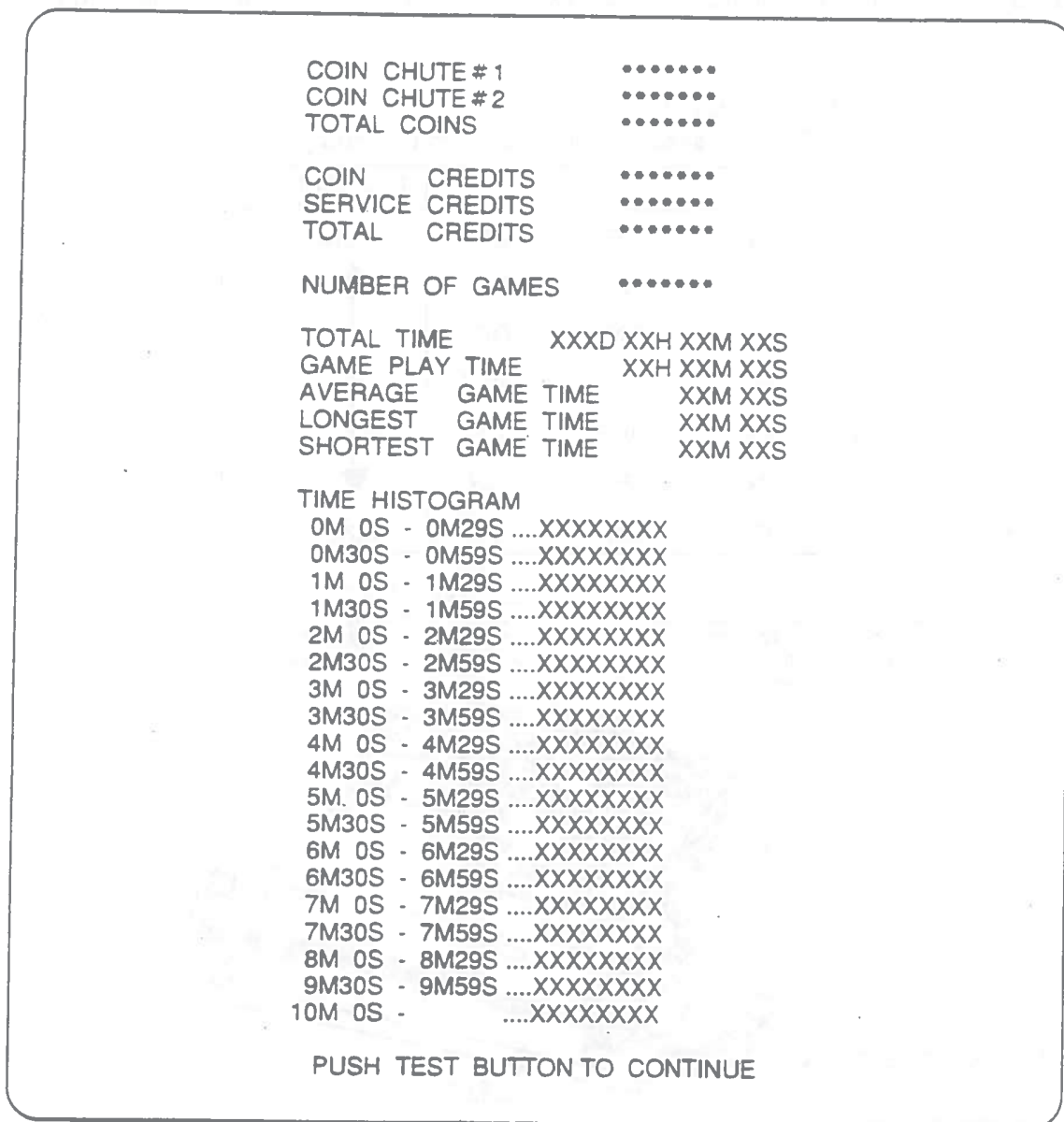

FIG. 8. 11a BOOKKEEPING

- COIN CHUTE#\* : Number of coins put in. As seen from the front of the cabinet, the right-hand side is #1 and the left-hand side is #2.
- TOTAL COINS: Total number of activations of coin chutes
- COIN CREDITS: Number of credits registered by inserting coins



- SERVICE CREDITS: Credits registered by the SERVICE button
- TOTAL CREDITS: Total number of credits (COIN CREDITS + SERVICE CREDITS)
- TOTAL TIME: The total energized time.
- TIME HISTOGRAM: By - playtime play frequency.

```

DESERT COURSE
TOTAL PLAY GAMES ...   XXXXX GAME
                    GOALS ... XXXXXX GOAL
                    TIME ... XX H XX M XX S
FASTEST GOAL TIME ...   XX M XX S
AVERAGE PLAY TIME ...   XX M XX S

FOREST COURSE
TOTAL PLAY GAMES ...   XXXXX GAME
                    GOALS ... XXXXXX GOAL
                    TIME ... XX H XX M XX S
FASTEST GOAL TIME ...   XX M XX S
AVERAGE PLAY TIME ...   XX M XX S

MOUNTAIN COURSE
TOTAL PLAY GAMES ...   XXXXX GAME
                    GOALS ... XXXXXX GOAL
                    TIME ... XX H XX M XX S
FASTEST GOAL TIME ...   XX M XX S
AVERAGE PLAY TIME ...   XX M XX S

CHAMPIONSHIP
TOTAL PLAY GAMES ...   XXXXX GAME
                    GOALS ... XXXXXX GOAL
                    TIME ... XX H XX M XX S
FASTEST GOAL TIME ...   XX M XX S
AVERAGE PLAY TIME ...   XX M XX S

PUSH TEST BUTTON TO EXIT

```

FIG. 8. 11b BOOKKEEPING

The steering wheel operates as per the designated setting. Press the TEST button or START button to return to the MENU mode.

## 12. Backup Data Clear

Clears the contents of BOOKKEEPING. When clearing, bring ">" to "YES (CLEAR)" and press the TEST button. When the data has been cleared, "COMPLETED" will be displayed. Bring ">" to "NO (CANCEL)" and press the TEST button or START button to return to the menu mode.

Also, note that the game setting contents are not affected by BACKUP DATA CLEAR operation.

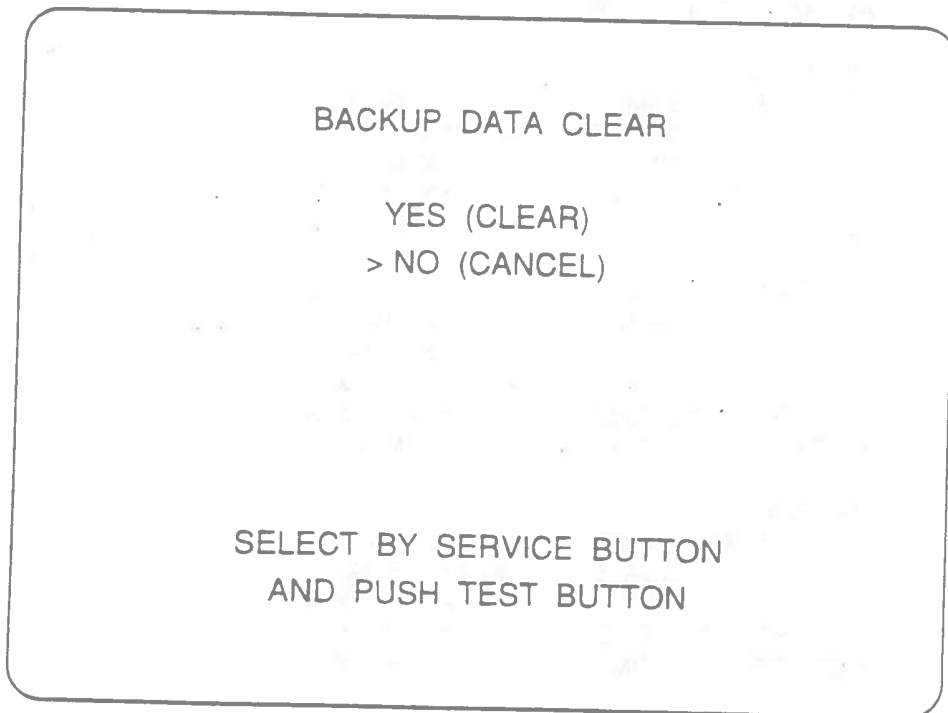
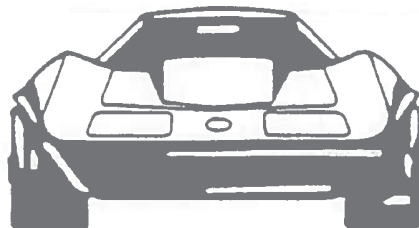

FIG. 8.12 BACKUP DATA CLEAR



## 8. MONITOR ADJUSTMENTS

### CAUTION!

- Do not operate the ADJUSTMENT knobs without good reason.
- A certain portion of the monitor is subject to a high voltage and therefore be very careful of this point.
- When making adjustment, utilize a resinous Alignment Screwdriver.

Remove LID on rear of cabinet to make the monitor adjustments.

NANAO monitor: 24K mode

Model: MS 8-26 SU  
2001-5187-15

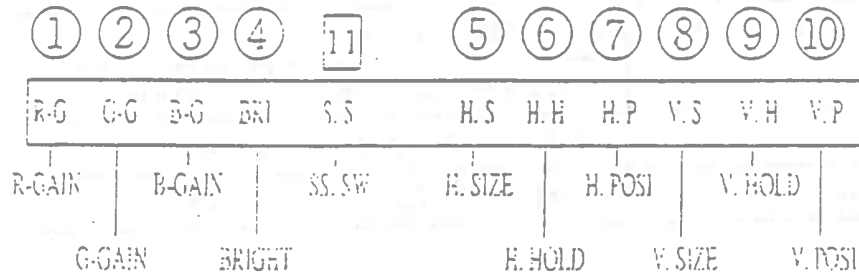

- ① R-GAIN
- ② G-GAIN ..... Controls colors.
- ③ B-GAIN
- ④ BRIGHT ..... Controls horizontal brightness.
- ⑤ H. SIZE ..... Controls horizontal screen size.
- ⑥ H. HOLD ..... Provides horizontal synchronization, i.e., controls right/left blurring of image.
- ⑦ H. POSI ..... Controls horizontal display position on screen.
- ⑧ V. SIZE ..... Controls vertical screen size.
- ⑨ V. HOLD ..... Provides vertical synchronization, i.e., controls up-down scrolling of image.
- ⑩ V. POSI ..... Controls vertical display position on screen
- ⑪ H. POSI ..... Controls the visual quality. (Only applies to Nanao.)

A: Ordinary    B: Super-sharpness

## 9. PERIODIC CHECK

---

The periodic check and maintenance of the items listed in Table 6 is suggested to retain the performance of this machine and to ensure safe business operation.

TABLE 6: PERIODIC CHECK AND MAINTENANCE ITEMS

ASSEMBLY	ACTION ITEM	INTERVAL
CONTROL	Check lamp	Monthly
	Check VOLUME VALUE	Monthly
ACCELERATOR AND BRAKE	Check VOLUME VALUE	Monthly
SHIFTER	Check SWITCH	Monthly
OVER/UNDER COIN DOOR ASSEMBLY	Check COIN SWITCH	Monthly
	Clean COIN SELECTOR	Tri-Monthly
MONITOR	Check ADJUSTMENTS	Monthly
GAME BOARD	Run MEMORY TEST	Monthly

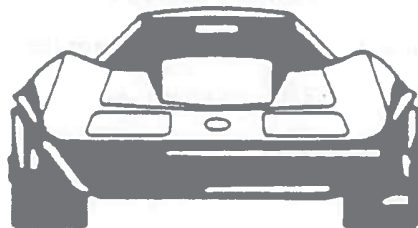

## 10. TROUBLESHOOTING

The items listed in Table 7 will assist in troubleshooting when a problem occurs. As a first step, check all wiring connector connections and verify AC power to the machine.

TABLE 7: TROUBLESHOOTING GUIDE

PROBLEMS	CAUSE	COUNTERMEASURES
When the main SW is turned ON, the machine is not activated.	The power is not ON. Incorrect power source/voltage. AC UNIT CIRCUIT PROTECTOR functioned due to instantaneous overcurrent.	Firmly insert the plug into the outlet. Make sure that the power supply/voltage are correct. First, remove the cause of overcurrent and reinstate the circuit protector to its original status.
MONITOR screen is blackened and the fluorescent lamp does not light up.	Power supply unit fuse blown off due to instantaneous overcurrent.	First remove the cause of overcurrent, then replace the fusc. <b>FUSE 5A 250V</b>
MONITOR screen is all blue.	Defective connections in between each board.	Make sure of correct connections in between each board.
The color of image on MONITOR screen is incorrect.	Incorrect monitor adjustment.	Make appropriate adjustments.
The on-screen image of the monitor sways and or shrinks.	The power source and voltage are not correct.	Make sure that the power supply and voltage are correct.
Control panel and pedal not operable satisfactorily.	V.R. position deviated, or V.R. malfunctioning.	Adjust or replace the V.R.
SHIFT LEVER doesn't operate satisfactorily.	Switch position deviated, or switch malfunctioning.	Adjust or replace the Switch. <b>SW MICRO TYPE</b>

TABLE 7: TROUBLESHOOTING GUIDE (cont.)

PROBLEMS	CAUSE	COUNTERMEASURES
Fluorescent lamp doesn't light up.	Fluorescent lamp needs replacement. The connector is disconnected. Primary fuse is blown	Replace the fluorescent lamp. Check connector connections in the marquee. Replace fuse.
Interactive play is not possible.	Communications cable is disconnected. Cable connections are not correct. Settings for communication play are not correct. Fiber optic cable is kinked.	Connect the cable. Connect the cable correctly. Ensure that the GAME SYSTEM settings are correct. Replace fiber optic cable.
Sound is not emitted.	Sound volume adjustment is not correct. Malfunctioning of sound board and/or memory.	Adjust the Service Panel's sound adjustment volume (control). Perform the SOUND TEST.

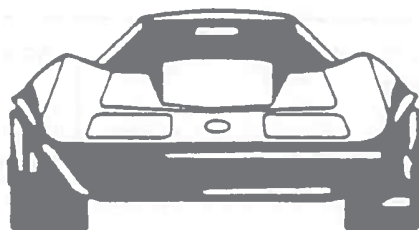

## 11. LINKING INSTRUCTIONS

---

This machine can be linked to similar machines to allow up to eight (8) people to race on the same course. Setting up LINKING requires modifications to Assembly, Game System Settings, and Playing Instructions as described in the following sections.

### 1. Assembly

Due to the length of the fiber optic communications cables, connected machine must be located within 12 feet of each other. Link the machines as shown in Figure 19, using the fiber optic cable found coiled inside each machine's cash box. Connect the cable to that machine's game board TX connector (see Figure 26, Section 13) and the next machine's game board RX connector. To link additional machines, simply insert machines between Machine A and Machine Z, shown in Figure 19, connecting successive TX outputs to RX inputs, with TX of Machine Z connected to RX of Machine A. Route the fiber optic cables through the slot in the rear of the machine case near the AC Unit to allow the rear panel to be reinstalled. Use care in handling the communication cables, as they are fiber optic and must not be kinked.

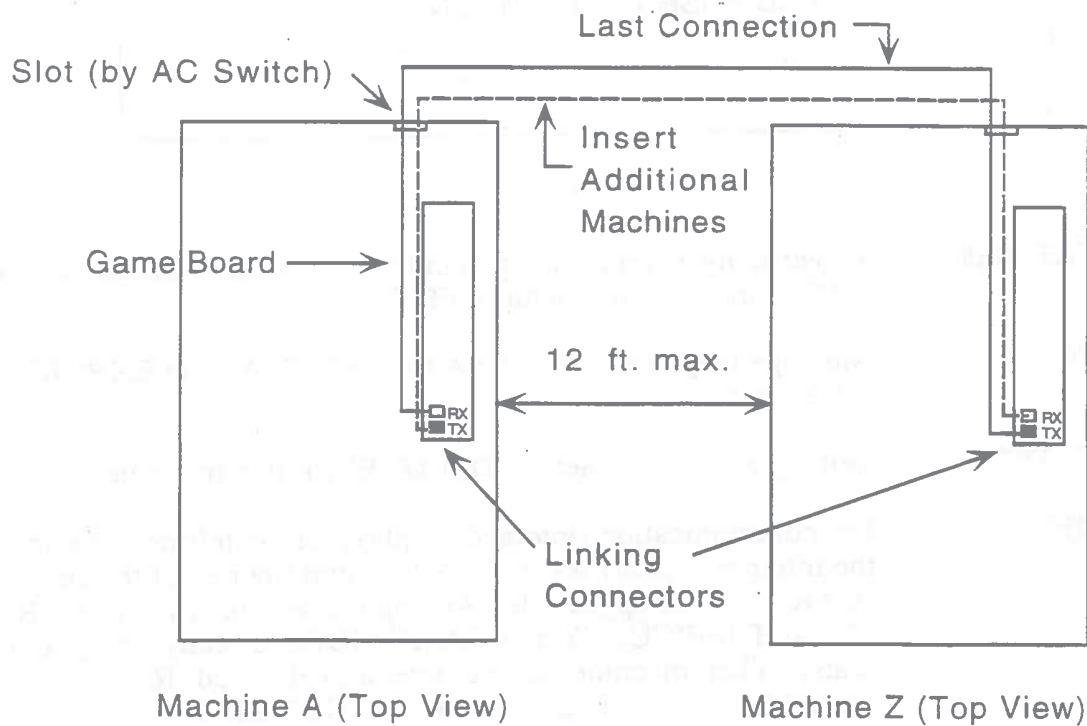

Figure 19: Linking Diagram

## 2. Game System Settings

Turn the power on and press the test switch to enter the test mode. Selecting the GAME ASSIGNMENTS causes the following screen to be displayed and allows settings such as game difficulty, etc., to be made. Make sure that each seat enters the test mode and settings for communication play are made.

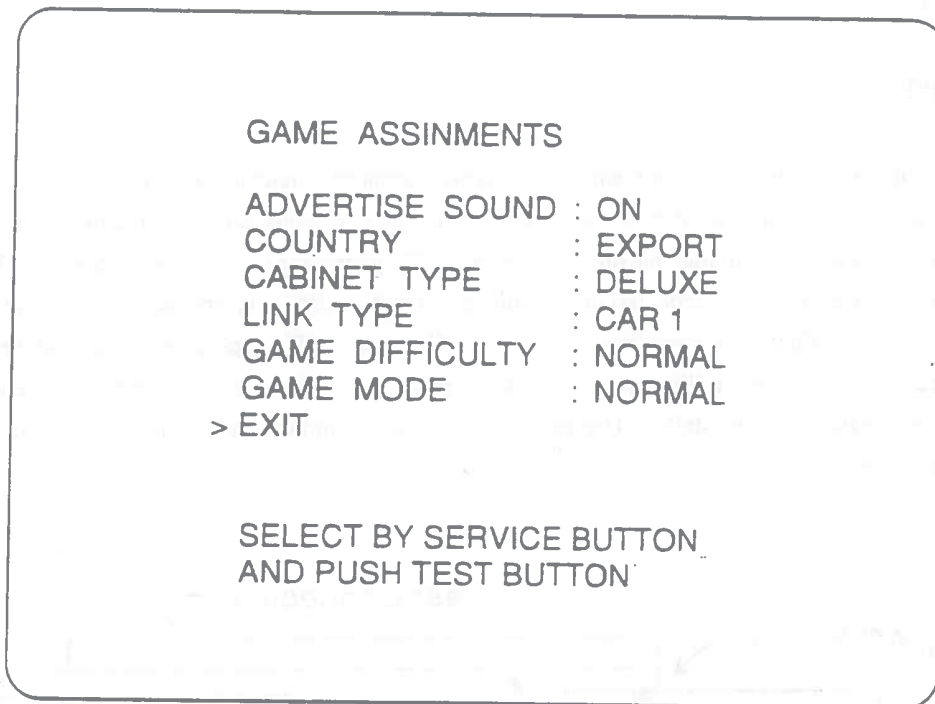

FIG. 19. 5

- **ADVERTISE SOUND** Advertising sound during standby. Sound is produced with "ON," and no sound with "OFF."
- **COUNTRY** Message language (select USA for the U. S. A., and EXPORT for other countries.
- **CABINET TYPE** Setting of cabinet. Set to "DELUXE" for this machine.
- **LINK TYPE** For communication (interactive) play, set the leftmost (facing the monitor screen) seat to "CAR 1," and the rest of the seats to "CAR 2~4" as applicable. Among the settings by the "CAR 1" seat, DIFFICULTY and GAME MODE directly apply to the seats. When machines are not interactively used (for communication), set all machines to "NOT LINK."
- **GAME DIFFICULTY** The game difficulty is classified into 4 different categories, i. e., EASY, NORMAL, HARD and HARDEST.
- **GAME MODE** Selection of laps. The following are the by-race laps:  
NORMAL, SHORT, LONG and LONGEST.



## SETTING CHANGE PROCEDURE

- ① Press the SERVICE BUTTON or VIEW CHANGE BUTTON to move the arrow (>) to the desired item.
- ② Choose the desired setting change item by using the TEST BUTTON or START BUTTON.
- ③ To return to the MENU mode, move the arrow to EXIT and press the TEST BUTTON or START BUTTON.

In the case of communication play, the game difficulty and the number of laps are set by the "CAR1" cabinet. The setting changes made by the "CAR1" cabinet apply to all the cabinets. Even if the setting is changed by the CAR2~4 machines, the setting will not be effective for the game.

Exiting from the test mode causes the unit to perform the network check automatically.

If the test results are satisfactory, approximately 30 seconds after all the machines entered the network check, the machines will be ready for starting the game. If, after an elapse of time exceeding one minute, the network check is not completed and the machine does not become ready for starting the game, turn all machines' power off and check optic fiber connections, etc.

During this time, all of the linked units will not allow the game to be played in normal status. Therefore, be sure not to enter the test mode if any one of the units is in play. On the other hand, if even one unit is in the mode, make sure that other machines are not in play.

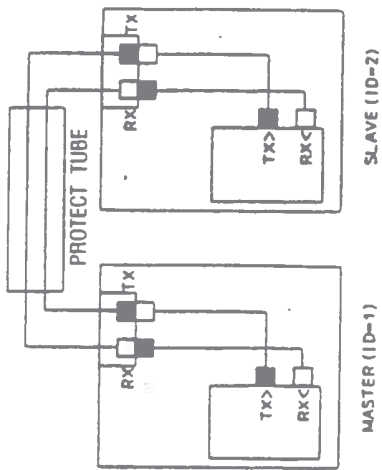

2P LINK

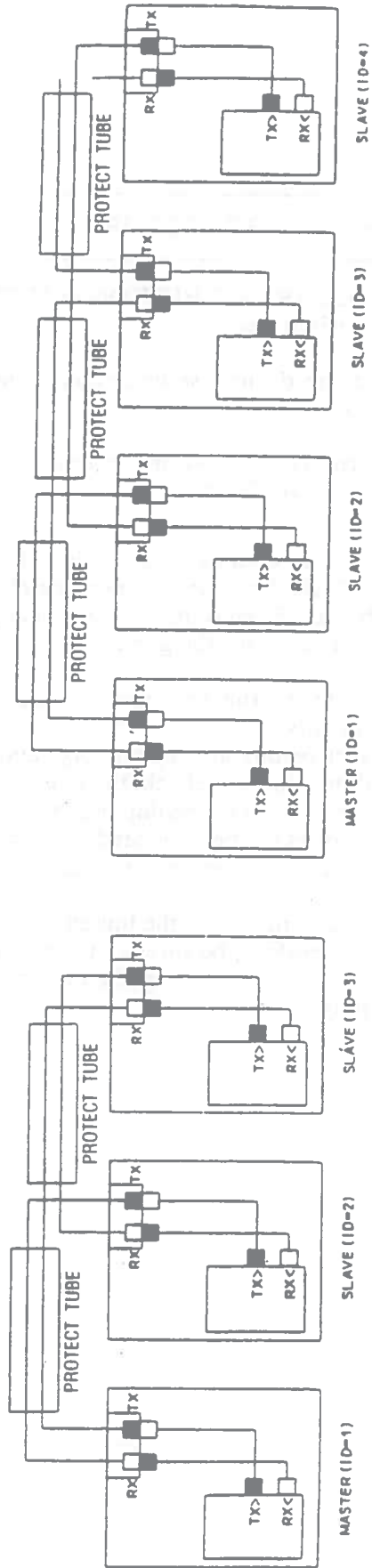

4P LINK

3P LINK

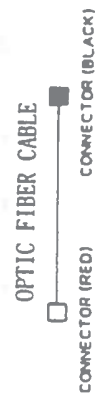

### 3. Playing Instructions

Most of the playing instructions in Section 6 apply to linked machines, with the following exceptions.

1. The player at the MASTER machine should insert a coin first, and press the start button. A message "WAITING FOR YOUR ENTRY" will appear on the remaining linked machine's monitors.
2. Within 14 seconds, each linked machine player who desires to compete must insert a coin in their coin slot.
3. Each player should select the course (Beginner, Advanced, or Expert) that they wish to compete on. The actual course selection will be determined by a majority of the linked players.
4. Shift selection is made independently on each machine. While making this selection, if you step on the Accelerator when the START button is pressed, only the cars of the actual linked machines will appear on the race course (no "phantom" competitors). This selection will also be determined by a majority of the linked players.
5. After AUTO or MANUAL shift has been selected, the race begins.

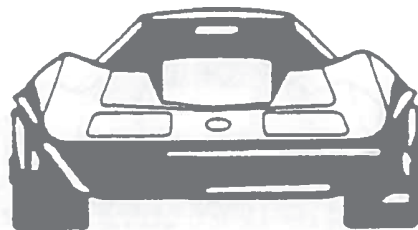

## 12. MACHINE OPTIONS

---

### A. Seat Kit

An add-on Seat Kit is available. Contact the distributor for ordering information.

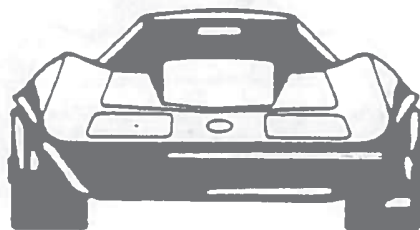

### 13. PARTS IDENTIFICATION

Figure 22: Marquee and Monitor Section

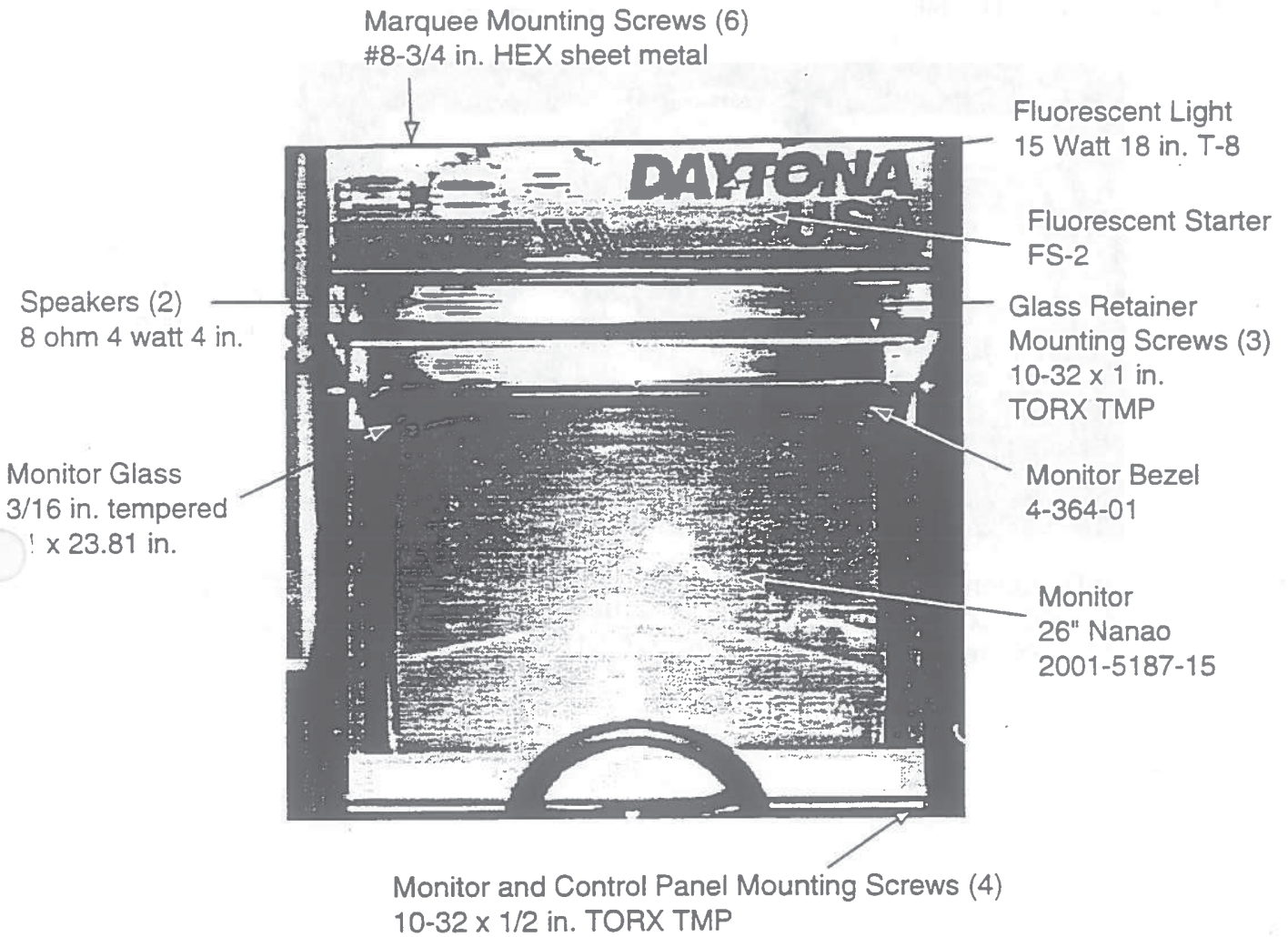
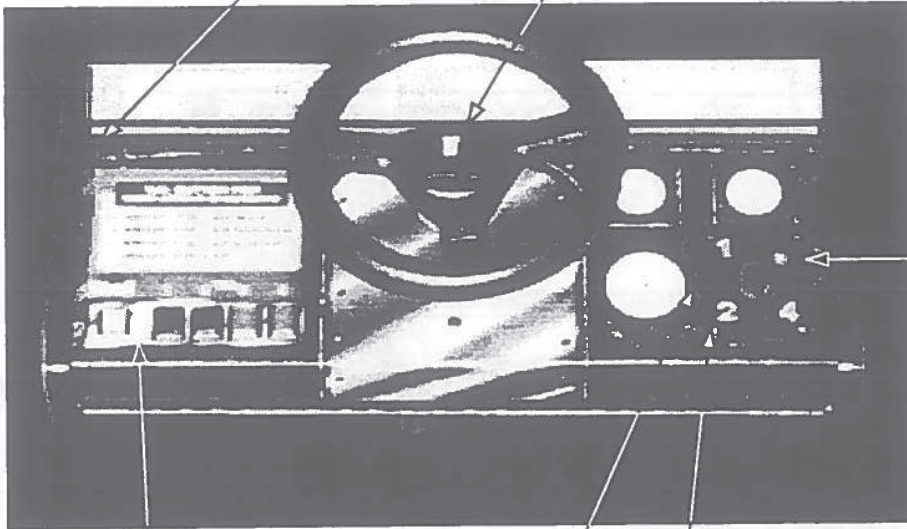

Figure 23: Control Panel Section

Monitor and Control Panel Mounting Screws (4)  
10-32 x 1/2 in. TORX TMP

Steering Wheel Assembly  
50-8070-00



Shifter Assy  
50-8495-05

V.R. Buttons (2)  
57-2000-xx  
(See Figure 31)

Shift Conversion  
Interface Harness  
(Internal) CA-819

Shifter Mounting Bolts (4)  
1/4 - 20 Carriage Bolts

Figure 24: RALLY Upright Graphics

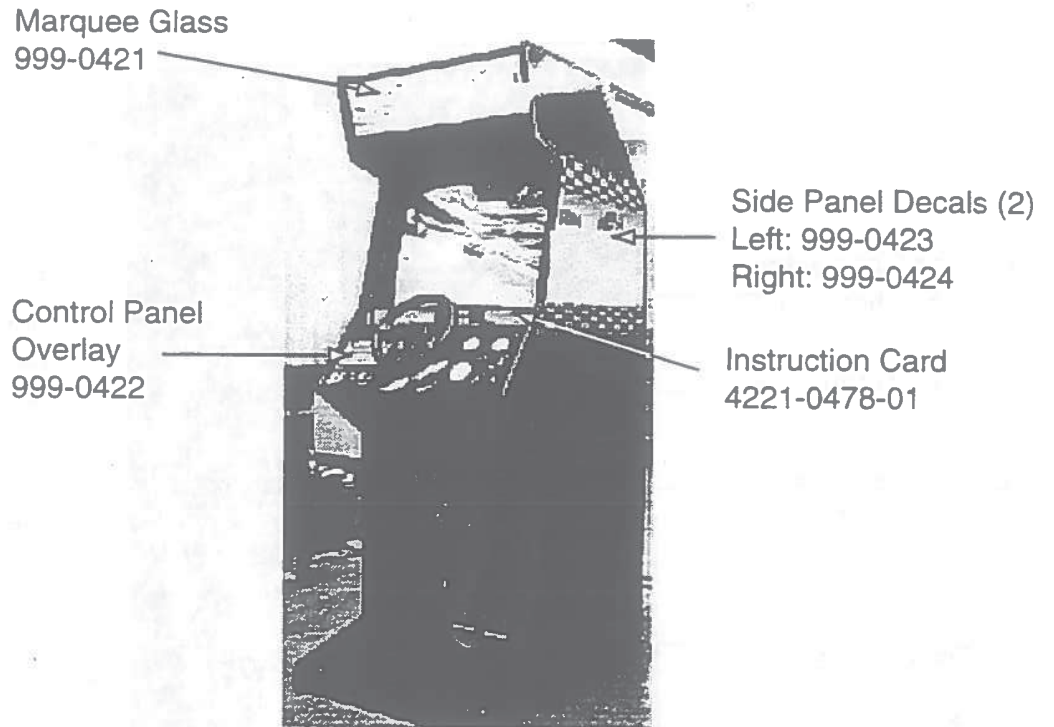

Figure 25: Over/Under Coin Door Assembly and Dual Pedal Section

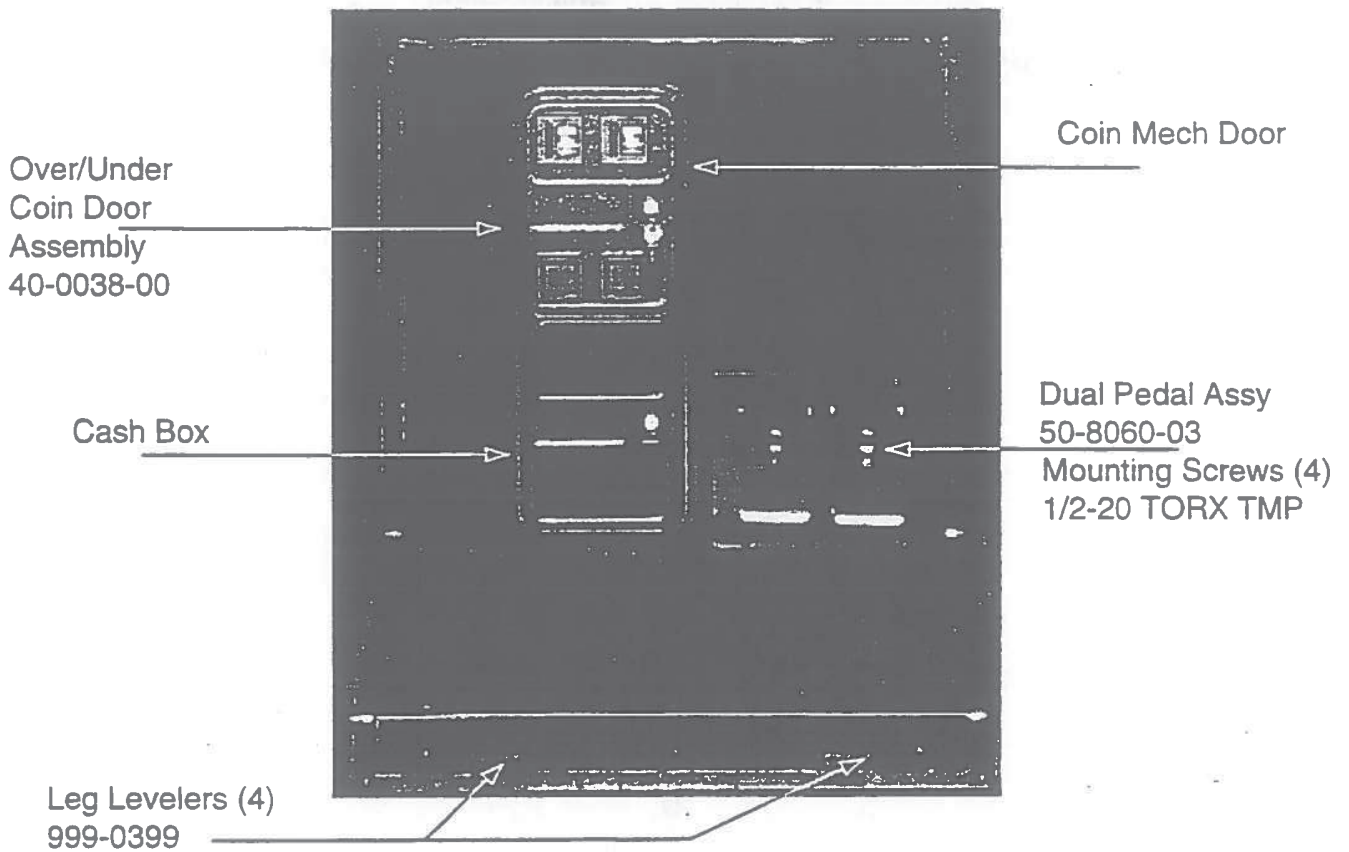

Figure 26: Internal Assemblies

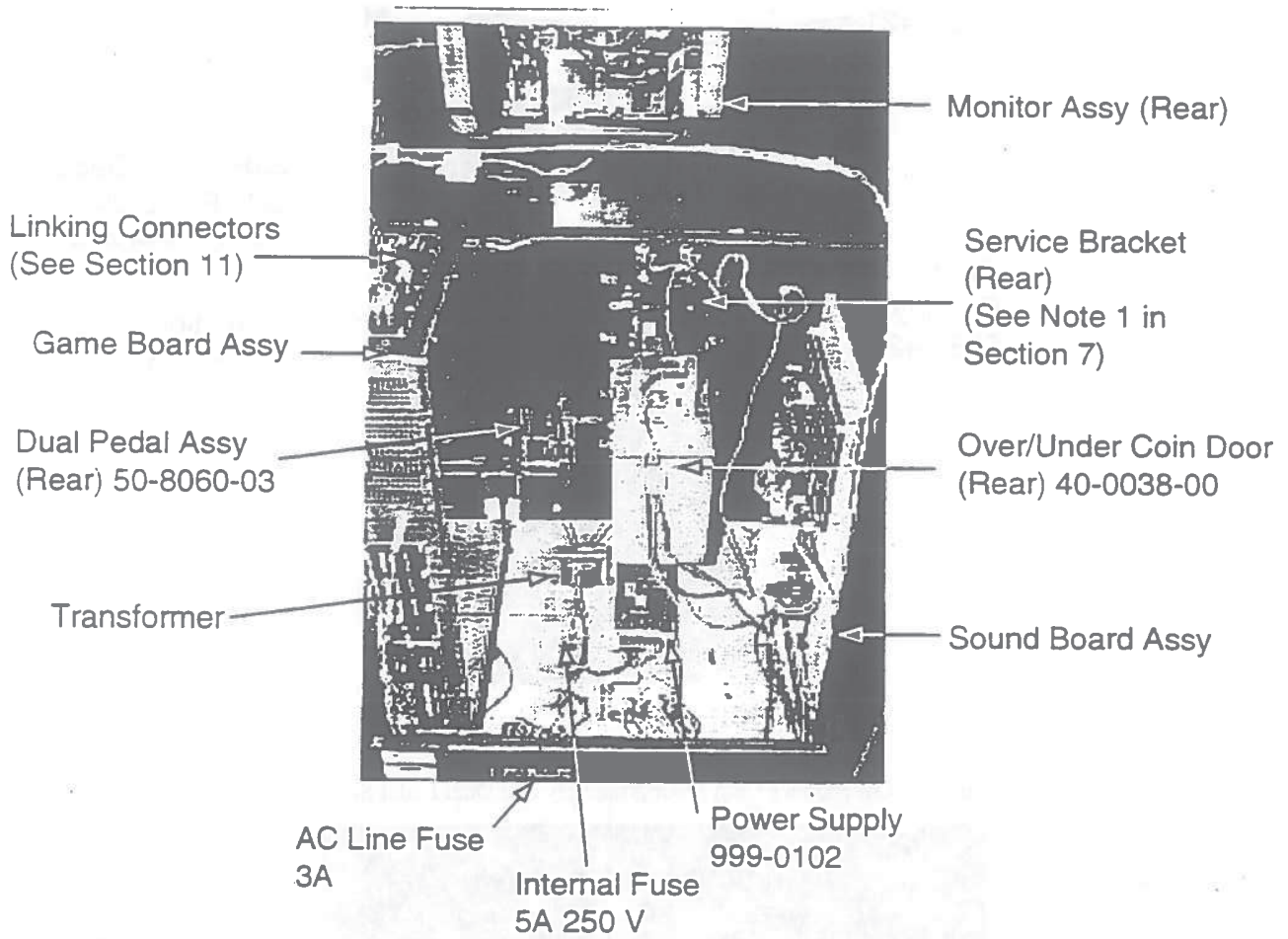



Figure 27: Shifter Assembly  
Part Number 50-8495-05

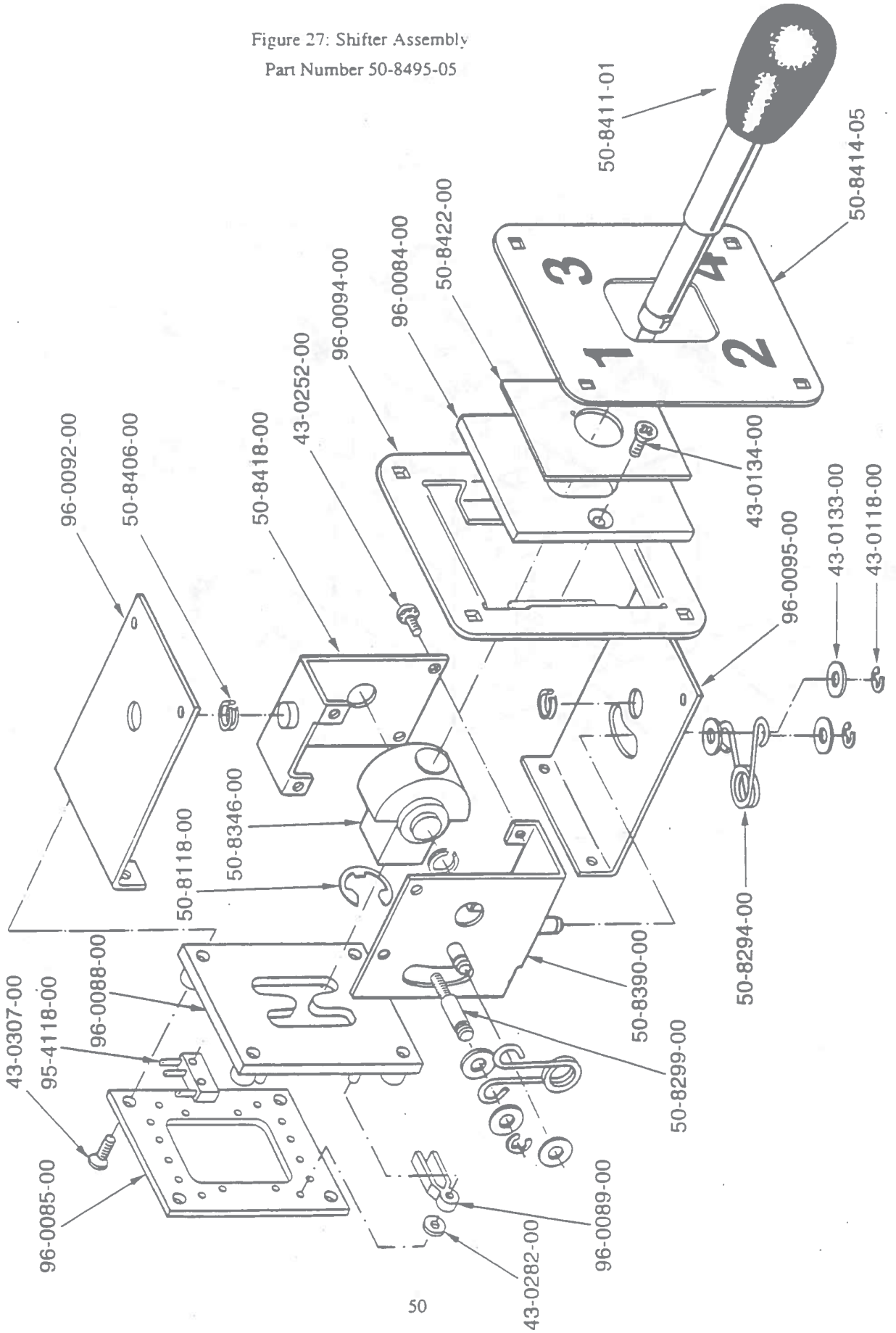

Figure 28: Dual Pedal Assembly  
Part Number 50-8060-03

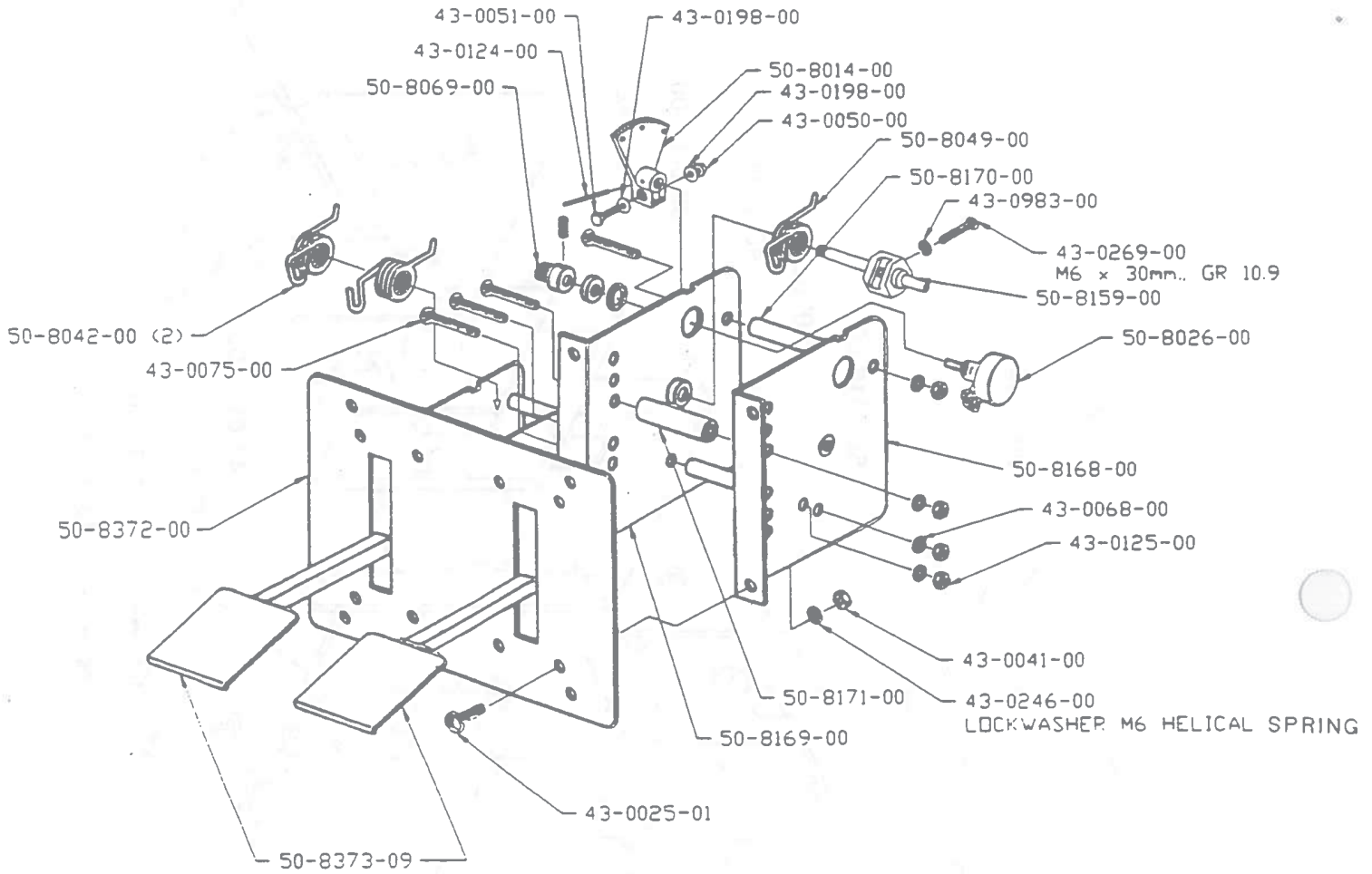

Figure 29: Over/Under Coin Door Assembly

Part Number 40-0038-00

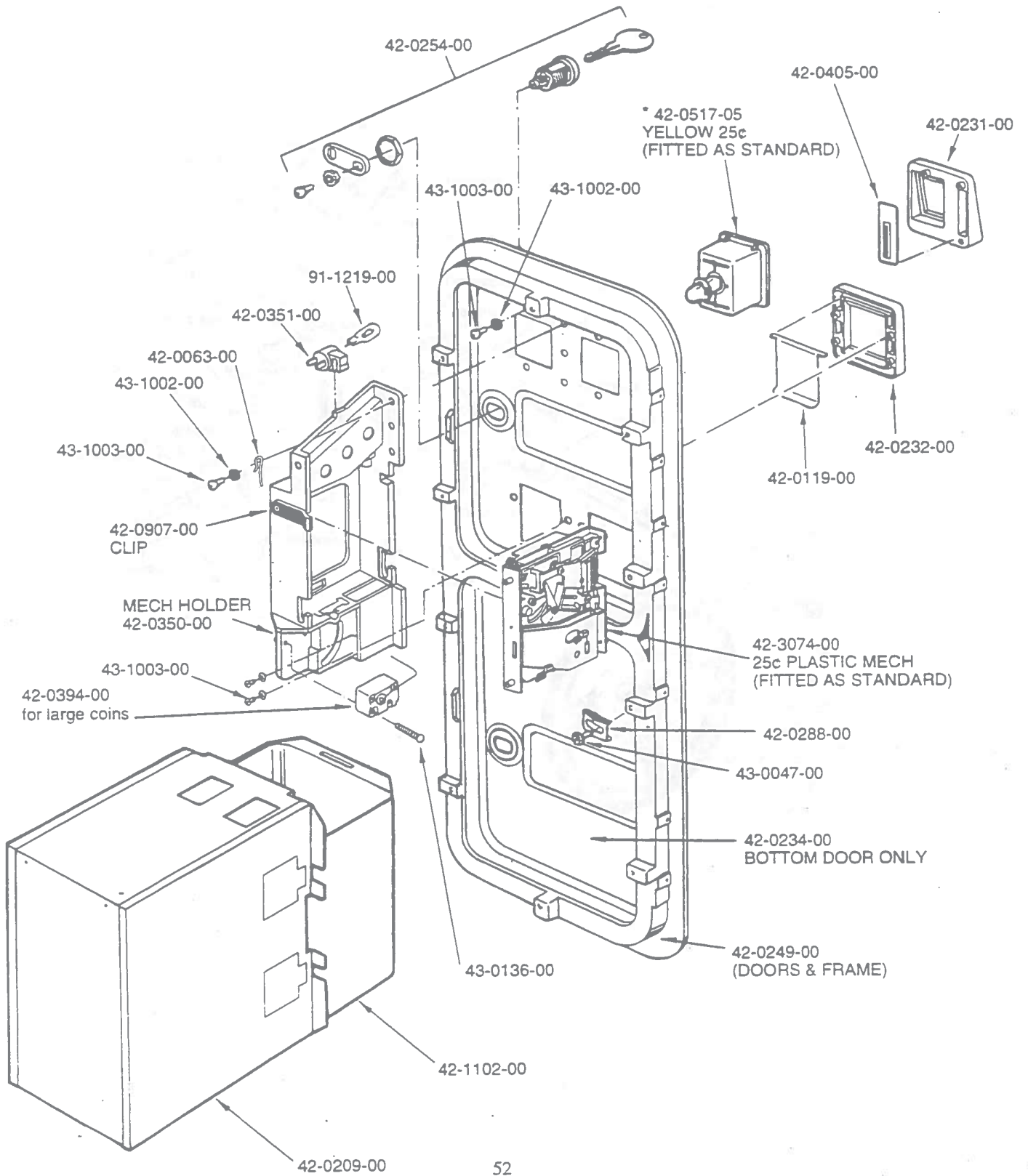
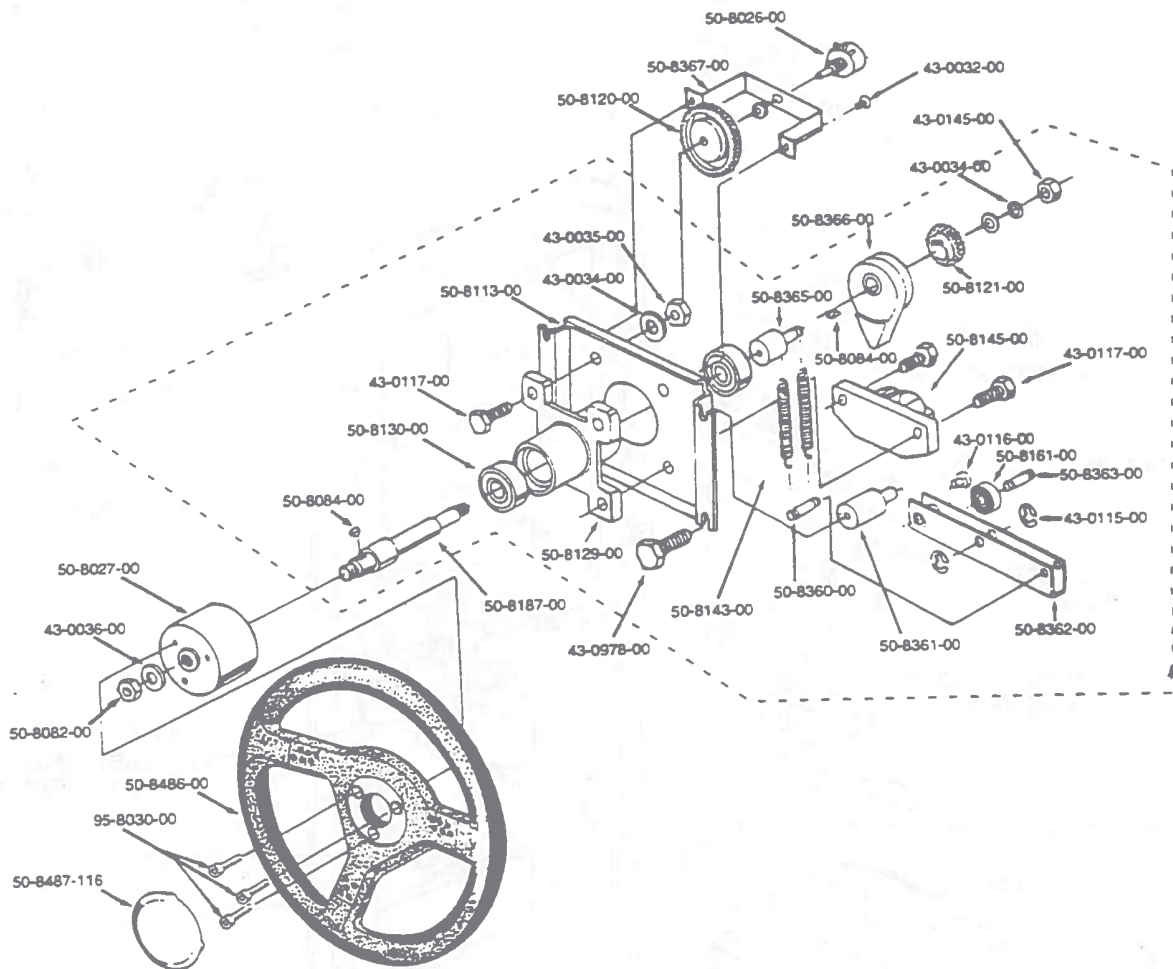

Figure 30: Steering Wheel Assembly  
Part Number 50-8070-00



**Figure 31: V.R. and Start Button Assembly**  
**Part Number (See Tables 8 - 11)**

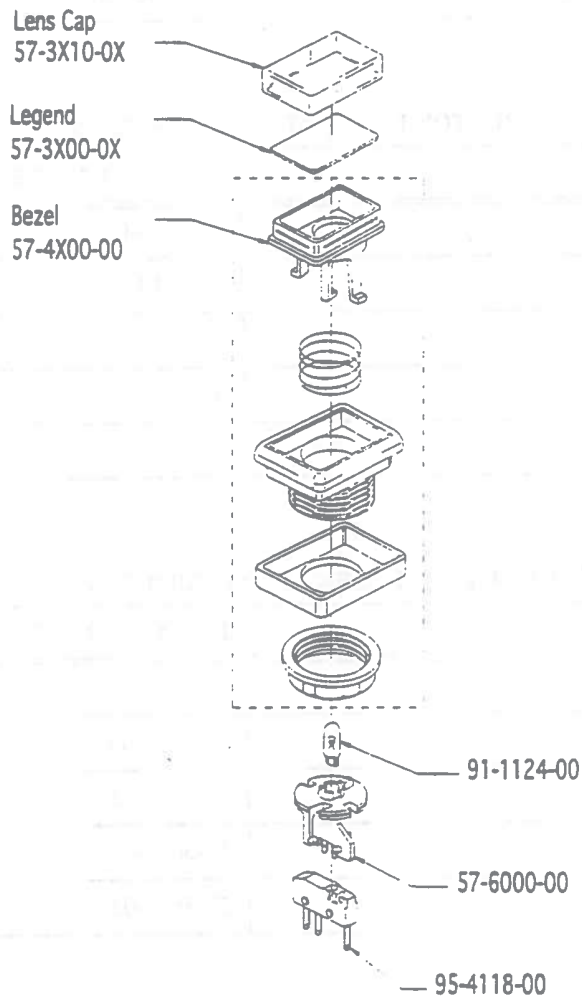

TABLE 8: V.R. AND START BUTTON ASSEMBLY PART NUMBERS

DESCRIPTION	PART NUMBER
Small Square White	57-2000-41
Medium Rectangle Red	57-2000-600
Medium Rectangle Blue	57-2000-622
Medium Rectangle Yellow	57-2000-655
Medium Rectangle Green	57-2000-633

TABLE 9: V.R. AND START BUTTON LENS CAP PART NUMBERS

DESCRIPTION	PART NUMBER
Small Square White	57-3410-08
Medium Rectangle Red	57-3610-00
Medium Rectangle Blue	57-3610-02
Medium Rectangle Yellow	57-3610-05
Medium Rectangle Green	57-3610-03

TABLE 10: V.R. AND START BUTTON LEGEND PART NUMBERS

DESCRIPTION	PART NUMBER
Small Square White	57-3400-01
Medium Rectangle Red	57-3600-00
Medium Rectangle Blue	57-3600-02
Medium Rectangle Yellow	57-3600-05
Medium Rectangle Green	57-3600-03

TABLE 11: V.R. AND START BUTTON BEZEL ASSEMBLY PART NUMBERS

DESCRIPTION	PART NUMBER
Small Square	57-4400-00
Medium Rectangle	57-4600-00

# 14. WIRING DIAGRAM

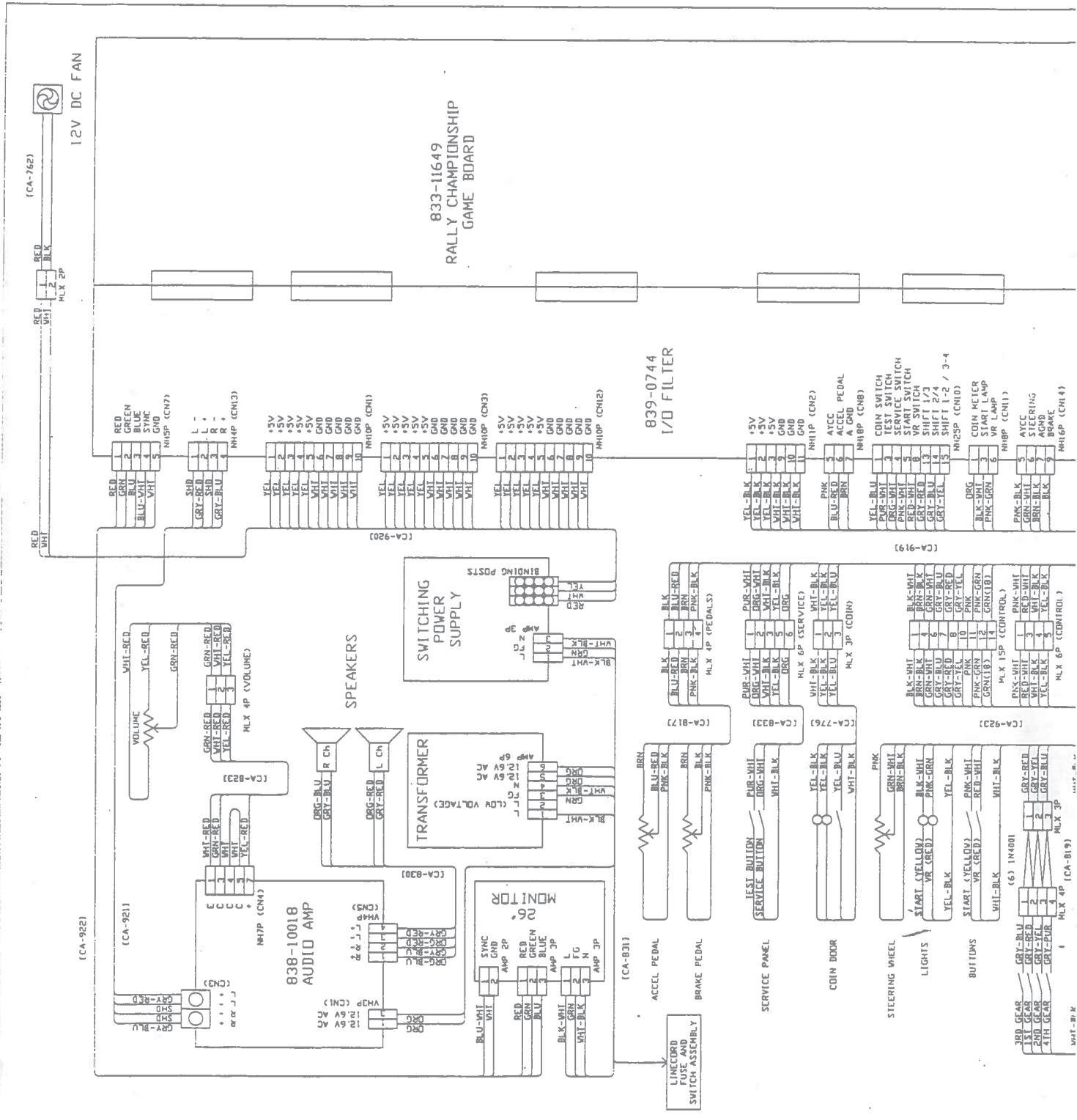





## COMMENTS ON RALLY UPRIGHT MANUAL

---

SEGA would like to make our manuals as correct and useful as possible. If you find any errors, omissions, or have other comments on this manual, please write them below, detach and deliver this page by FAX or mail to:

ATTN: Engineering Dept.  
SEGA ENTERPRISES INC. (USA)  
45133 Industrial Drive  
Fremont, CA 94538 USA  
FAX: (415) 802-1754

---

---

---

---

---

---

---

---

### Optional Information:

Name: \_\_\_\_\_  
Address: \_\_\_\_\_  
City, State, Zip: \_\_\_\_\_  
Phone: \_\_\_\_\_  
FAX: \_\_\_\_\_

