

MVS[®]
MULTI VIDEO SYSTEM
SERVICE
MANUAL

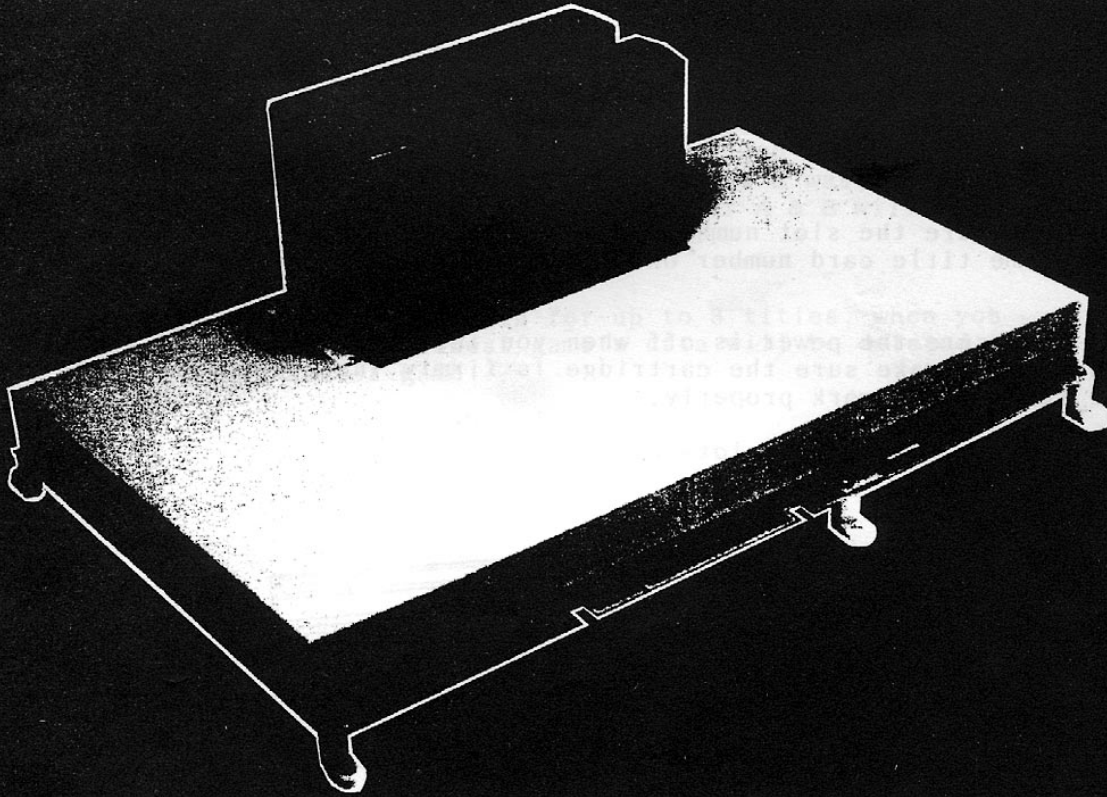

SNK

○ WARNING

1) Make sure the game cartridge is installed with the markings matching the main board.

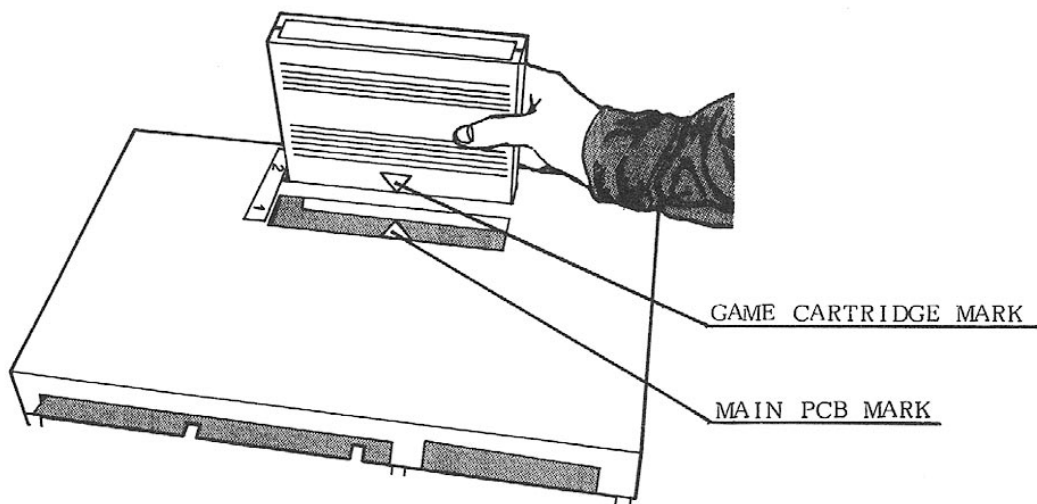

2) Make sure the slot number you install the cartridge in matches the game title card number on the EL panel.

3) Make sure the power is off when you insert or remove the cartridge. Make sure the cartridge is firmly inserted in the slot or it will not work properly.

4) Protect the unused slots with a cover or tape.

SLOT NUMBER FOR CARTRIDGE
SHOULD MATCH THE NUMBER OF
THE GAME TITLE CARD

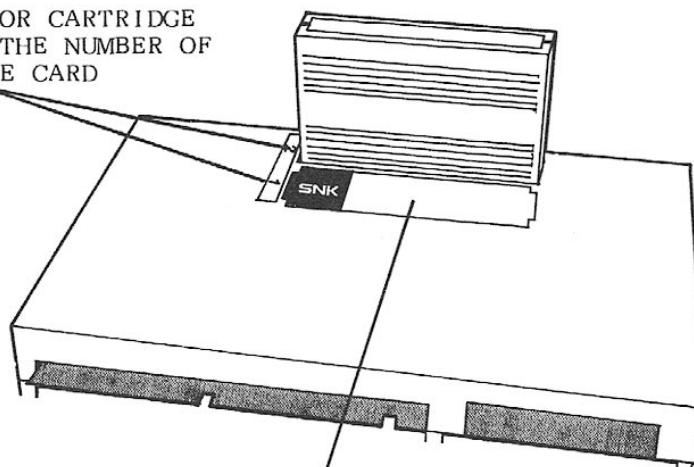

PROTECT THE UNUSED SLOTS
WITH A COVER OR TAPE

- 5) Do not put any electric conductive materials on or in the slots.
- 6) Do not insert any other cartridge than the MVS cartridge with the 240 pin connector.
The NEO GEO Rental System cartridge will not fit on this connector!
- 7) MVS preserves the income data of max 8 games even the power is off or the game cartridges are removed from PCB.

For example: 2 cartridges are being used, A,B, on the MVS.
If new game titles C & D are used to replace A & B, the date for A & B will remain.

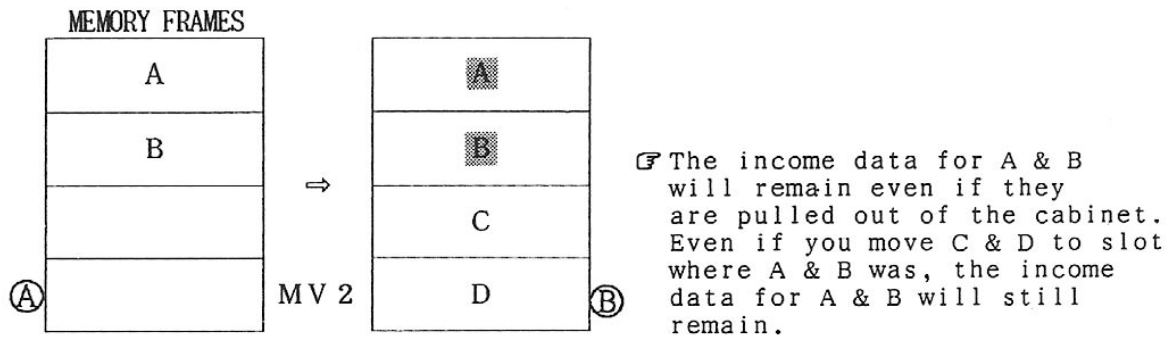

Since the MVS can only retain data for up to 8 titles, when you install the next game, the oldest game's data will be deleted to input the data for newest game.

OP. C. B. COMPONENT

① MVS consists of 4 different P.C.Bs.

NEO-MVH MV2····Main programming, characters
Switching game cartridge

② Each board connects as follows:

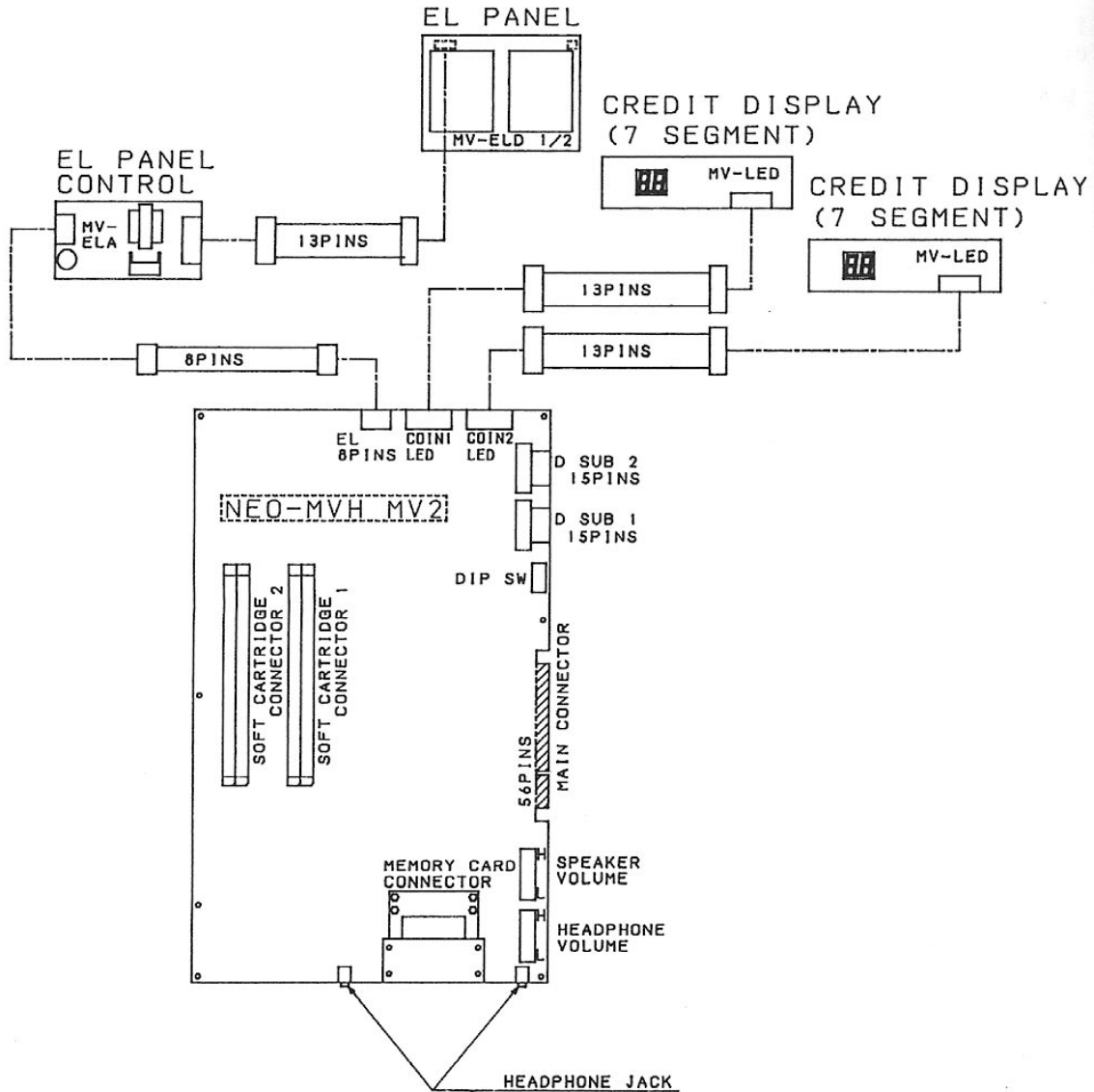

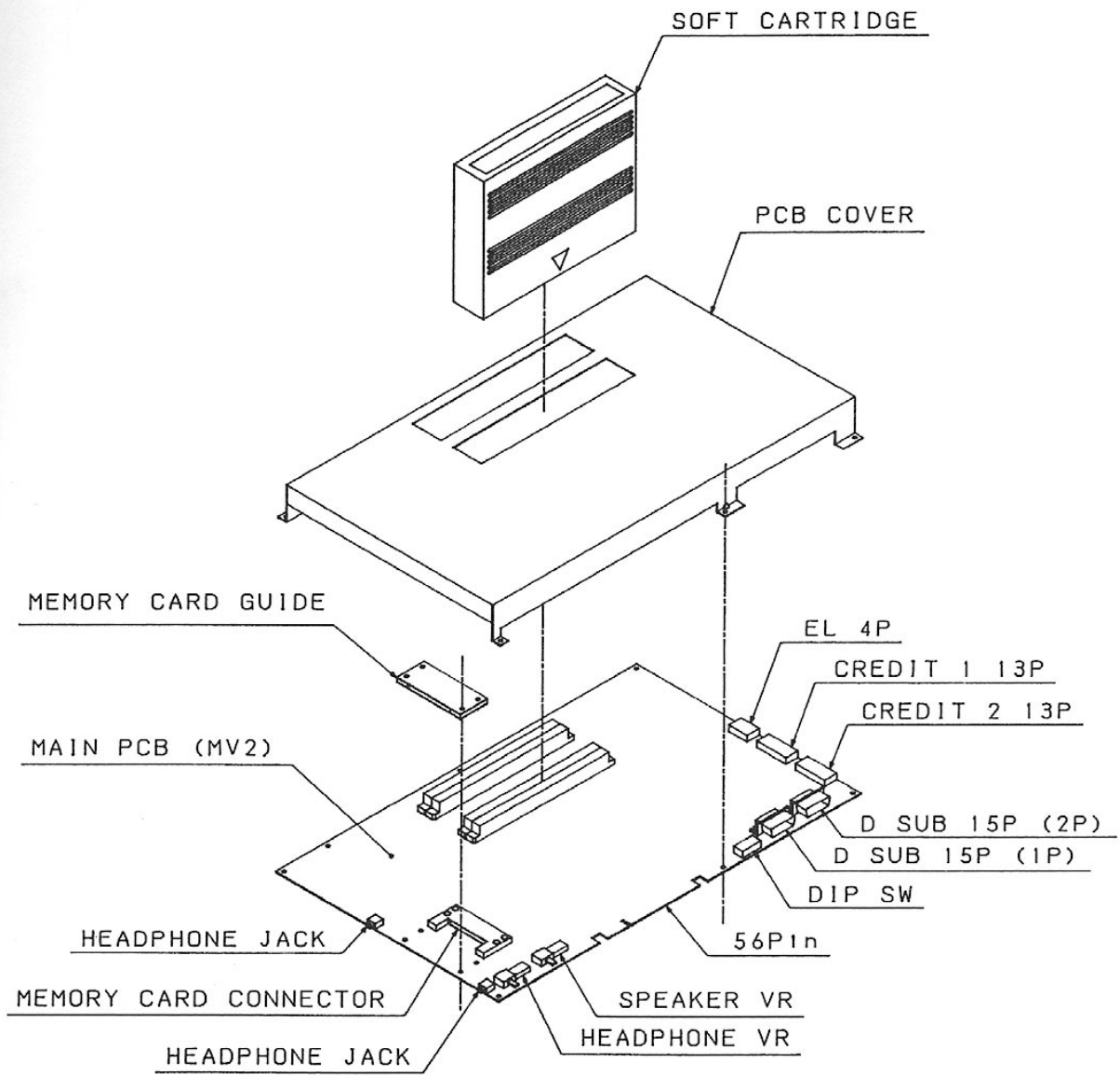

OMODE SETTING

The MVS (Multi Video System) enables the dip settings to appear on the monitor instead of the dipswitch settings on conventional pcbs. It allows you to obtain collection information, game times, etc. The following are the directions on how to operate and choose settings:

How to operate: After turning the power on, press the test switch inside the cabinet.

☞ Move the cursor to your selection with the joystick and press "A" button.

MAIN MENU

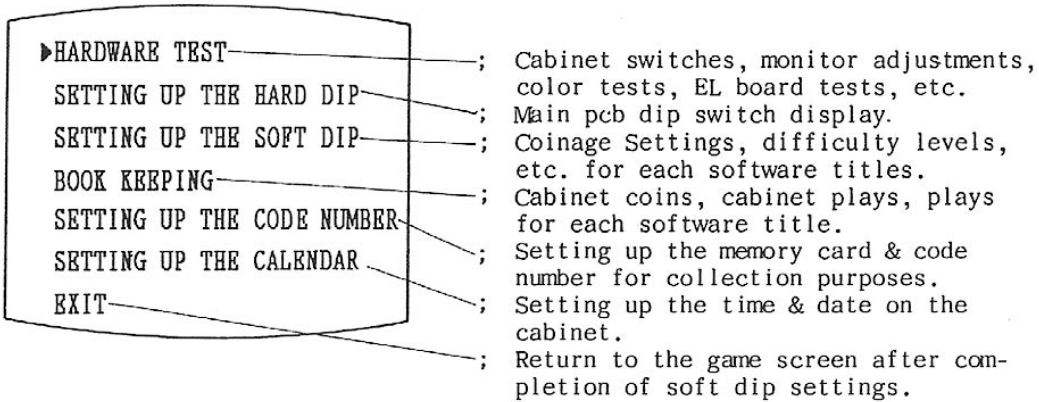

HARDWARE TEST

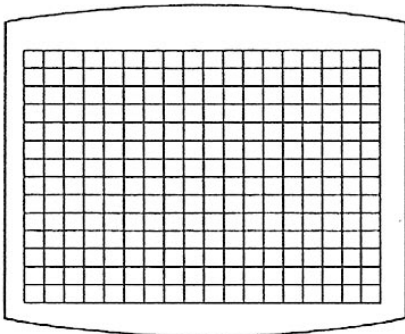

; Cross Hatch



☞ Press the 1 player start button

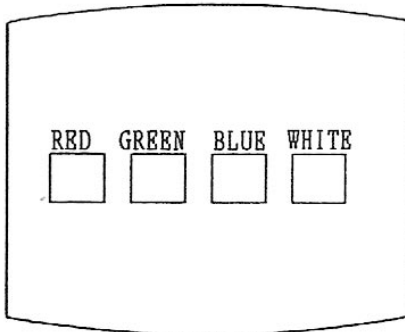

☞ Use this screen to adjust the color on the monitor



☞ Press the 1 player start button

I/O CHECK					
	P1	P2	12345678		
UP	0	0	00000000		
DOWN	0	0			
LEFT	0	0	TEST	0	
RIGHT	0	0	COIN1	0	
PUSH1	0	0	COIN2	0	
PUSH2	0	0	SERVICE	0	
PUSH3	0	0			
PUSH4	0	0	EL LED1	LED2	
START	0	0	0	00	00
SELECT	0	0			



SOUND TEST	
	SOUND OFF
	RIGHT
	LEFT
	CENTER



MEMORY CARD TEST	
	INSERT MEMORY CARD



BACKUP CLEAR	
	OK=PUSH A, B, C BUTTON

- ☒ With the dipswitch "on" the number 1 appears on the screen. With the dipswitch "off" the number 0 appears on the screen.
- ☒ Check if the number for EL on the screen is the same as the EL panel illuminated on the board.
- ☒ Check if the number of LED 1 is the same as displayed on the LED on the control panel.

☒ Press the 1 player start button

- ☒ The area in red on the monitor moves from "sound off" to "center" by moving the joystick up and down.
 - RIGHT Sound comes out the right side speaker
 - LEFT Sound comes out the left side speaker
 - CENTER Sound comes out both speakers

☒ Press the 1 player start button

- ☒ You can check if the memory card works properly by inserting it during this screen.
NOTE: Data that was already saved on the memory card will be erased.

☒ Press the 1 player start button

- ☒ When you press the A, B, & C buttons simultaneously, you will clear the data.



☞ Press 1P button to start

SETTING UP THE CALENDAR
 CURRENT TIME
 17/ 2/90 SAT
 19:30:41
 THE TIME TO BE SET UP
 A BUTTON, JOYSTICK=SELECT
 17/ 2/90 19:30:41

☞ Red number is changeable. Increase number with "A" button, decrease number with "B" button. Press "D" button when finished with setting.

☞ Press 1P button to start

RETURN TO THE CROSS HATCH.

HARD DIP SETTING

SETTING UP THE HARD DIP
 12345678
 SETTING MODE 1..... ON
 COMMUNICATION ...000.. OFF
 FREE PLAY .0 OFF
 COIN SWITCH ..0..... 2
 STOP MODE0 OFF
 0=OFF 1=ON

☞ Shows present state of dipswitch.

SETTING UP THE SOFT DIP

▶SETTING UP THE CABINET
 SLOT1 NAM-1975
 SLOT2 BASEBALL STARS
 SLOT3 MAHJONG
 SLOT4 TOP PLAYERS GOLF
 SLOT5 MAGICIAN LORD

☞ Cabinet setting

; Each software setting

↓
SETTING UP THE CABINET

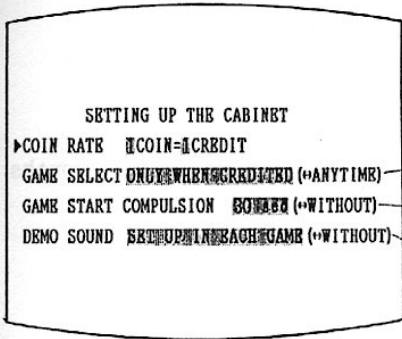

- ☞ Move cursor to "cabinet setting" and press "A" button.
- ☞ Move the cursor by joystick and increase with "A" button, decrease with "B" button.
- ☞ On "free play", selection button works without credits. (Change with "A" button.)
- ☞ Setting of time limitation after inserting coin. (Change with "A", "B" button)
- ☞ When "without" appears, there is no sound for any of the games. (Change with "A" button)
- ☞ Return to previous menu with "C" button. Move cursor to the game you wish to set and press "A" button.

↓
In the case of NAM-1975
(In the case of each game)

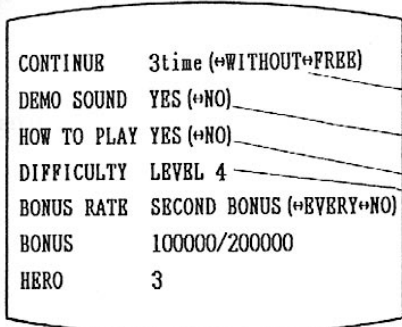

- ☞ Software dips are slightly different by game. ; Set number of continue plays.
- ☞ When there is no "demo sound" on cabinet setting, "with" will be ignored. ; With or without game play instructions ; when game starts.
- ☞ Difficulty setting. The higher the number, the more difficult.

↓
BOOK KEEPING

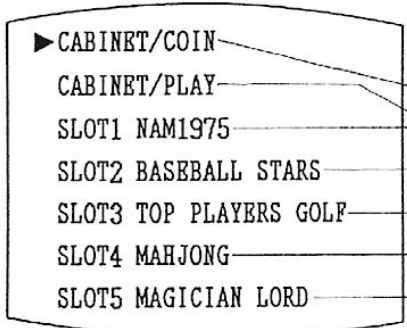

- ☞ Press "C" button once to return to "Soft dip menu setting". Press "C" button again to return to main menu. Be sure to press "C" button after making game selection.

- ☞ Move the cursor to "Book Keeping" with joystick and press "A" button.
- ☞ ; Total coins of cabinet
- ☞ ; Total plays, number of continue plays for the cabinet
- ☞ ; Total plays, number of continue plays for each title

↓
CABINET/COIN

CABINET/COIN			
	P1	P2	SERVICE
FEB/17	02244	0	25
FEB/16	04422	0	36
FEB/15	06633	0	47
FEB/14	08844	0	48
FEB/13	02399	0	29
FEB/12	05699	0	94

- ☞ Move the cursor to cabinet/coin with joystick and press "A" button.

- ☞ Weekly income chart.



☞ Press "A" button

CABINET/COIN			
	P1	P2	SERVICE
JAN	42244	0	25
FEB	44422	0	36
MAR	56633	0	47
APR	68844	0	48
MAY	72399	0	29
JUN	55699	9	94

Cabinet coins for the first 6 months of the year.



☞ Press "A" button

CABINET/COIN			
	P1	P2	SERVICE
JUL	42244	0	25
AUG	44422	0	36
SEP	56633	0	47
OCT	68844	0	48
NOV	72399	0	29
DEC	55699	0	94

Cabinet coins for the second 6 months of the year.

☞ After pressing "C" button, move the cursor to "Cabinet Play" and press "A" button.



☞ Press "A" button

CABINET/PLAY

CABINET/PLAY			
	PLAY	CONT.	AV. TIME
FEB/17	22	33	5:20
FEB/16	44	55	6:20
FEB/15	66	77	7:20
FEB/14	88	99	8:20
FEB/13	23	32	9:20
FEB/12	56	55	4:20
FEB/11	11	88	5:20



☞ Press "A" button

CABINET/PLAY			
	PLAY	CONT.	AV. TIME
JAN	42244	33363	5:20
FEB	44422	35543	6:20
MAR	56633	37773	7:20
APR	68844	39983	8:20
MAY	72399	33232	9:20
JUN	55699	15519	4:20



☞ Press "A" button

CABINET/PLAY			
	PLAY	CONT.	AV. TIME
JUL	42244	33363	5:20
AUG	44422	35543	6:20
SEP	56633	37773	7:20
OCT	68844	39983	8:20
NOV	72399	33232	9:20
DEC	55699	15519	4:20

☞ Retrieve book keeping information for each software title the same way as "Cabinet Coin" & "Cabinet Play".



SETTING UP THE CODE NUMBER

CODE NUMBER SETTING
 2408
 D BUTTON:SET
 CODE NUMBER WILL BE SET INTO
 MEMORY CARD WHEN INSERTED
 DURING THIS MODE.

☞ After pressing the "C" button twice, return to the main menu. Press "A" button after selection CODE NUMBER SETTING with the joystick.

☞ Increase numbers with the "A" button. Decrease numbers with the "B" button. Use the joystick to move left to change selected numbers. Set Code Number Setting with the "D" button.

The total data of book keeping can be collected by these procedure.

OMULTI VIDEO INCOME TOTALIZATION SYSTEM (Book Keeping System)

1) The Muti Video System (MVS) is equipped with back-up ram and calendar IC which allows the daily income data to be saved even when the power is off.

2) After pressing the test button and selecting "Book Keeping" from the menu, you can view the "Income Data" on the screen.

3) One exclusive Memory Card is capable of saving the income data of several cabinets.

4) The collected data from the memory card used in connection with the exclusive card reader enables you to check the entire income totals on your personal computer.

* Memory card, memory card adapter, and card reader are option.

OMV2, SLOT2 PCB ASSEMBLY

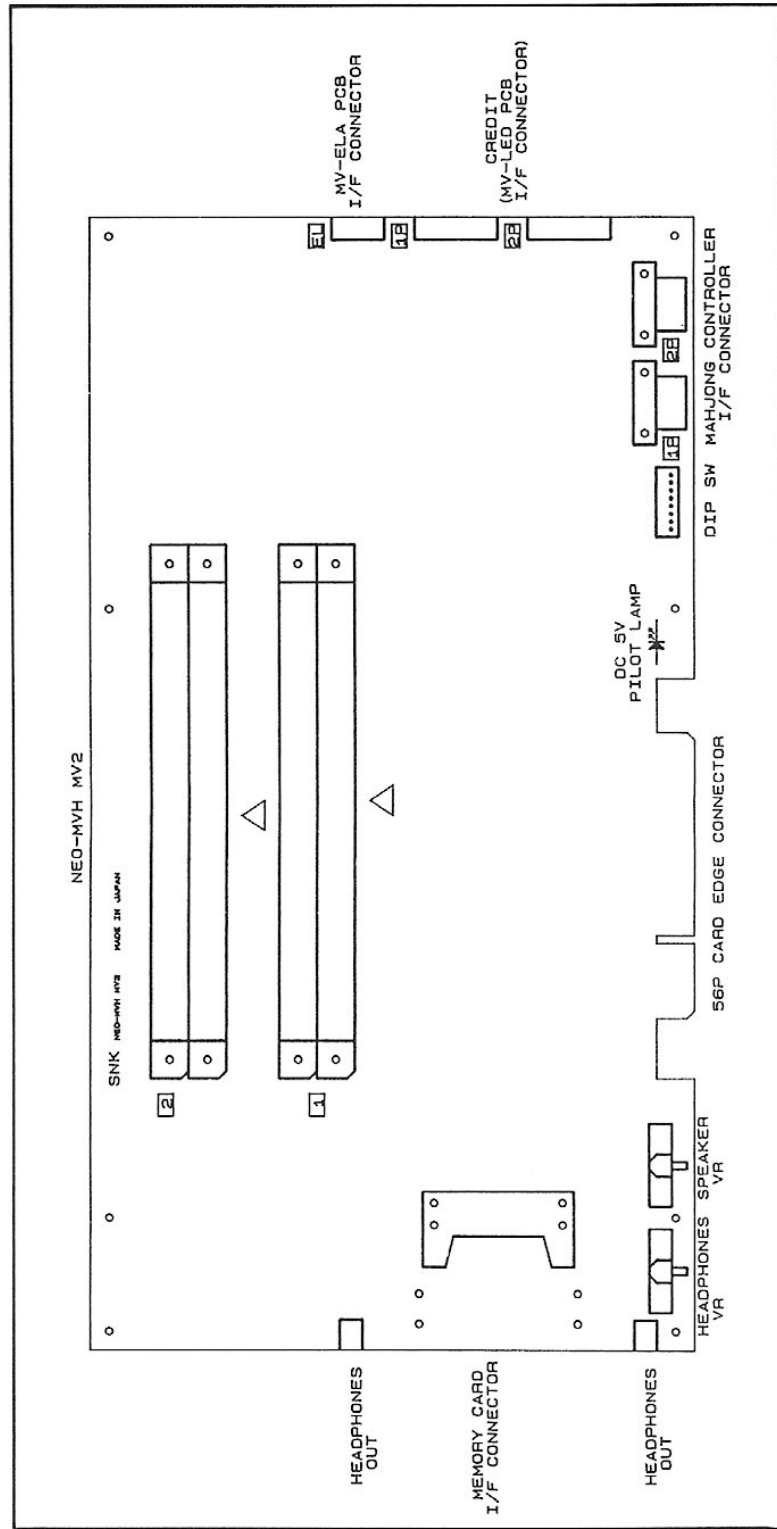

OMAIN HARNESS

SOLDER SIDE	PIN #		PART SIDE
GND	A	1	GND
GND	B	2	GND
+5V	C	3	+5V
+5V	D	4	+5V
	E	5	
+12V	F	6	+12V
KEY	H	7	KEY
COIN COUNTER 2	J	8	COIN COUNTER 1
COIN LOCK OUT2	K	9	COIN LOCK OUT1
SPEAKER+ (L)	L	10	SPEAKER+ (R)
TEST SWITCH	M	11	AUDIO + (mono)
VIDEO GREEN	N	12	VIDEO RED
VIDEO SYNC	P	13	VIDEO BLUE
SERVICE SW	R	14	VIDEO GND
COIN SW4 (P2/ 2)	S	15	COIN SW3 (P1/2)
COIN SW2 (P2/ 1)	T	16	COIN SW1 (P1/1)
START 2	U	17	START 1
PLAYER2 UP	V	18	PLAYER1 UP
PLAYER2 DOWN	W	19	PLAYER1 DOWN
PLAYER2 LEFT	X	20	PLAYER1 LEFT
PLAYER2 RIGHT	Y	21	PLAYER1 RIGHT
PLAYER2 PUSH1	Z	22	PLAYER1 PUSH1
PLAYER2 PUSH2	a	23	PLAYER1 PUSH2
PLAYER2 PUSH3	b	24	PLAYER1 PUSH3
PLAYER2 PUSH4	c	25	PLAYER1 PUSH4
SELECT DOWN	d	26	SELECT UP
GND	e	27	GND
GND	f	28	GND

WIRING DIAGRAM

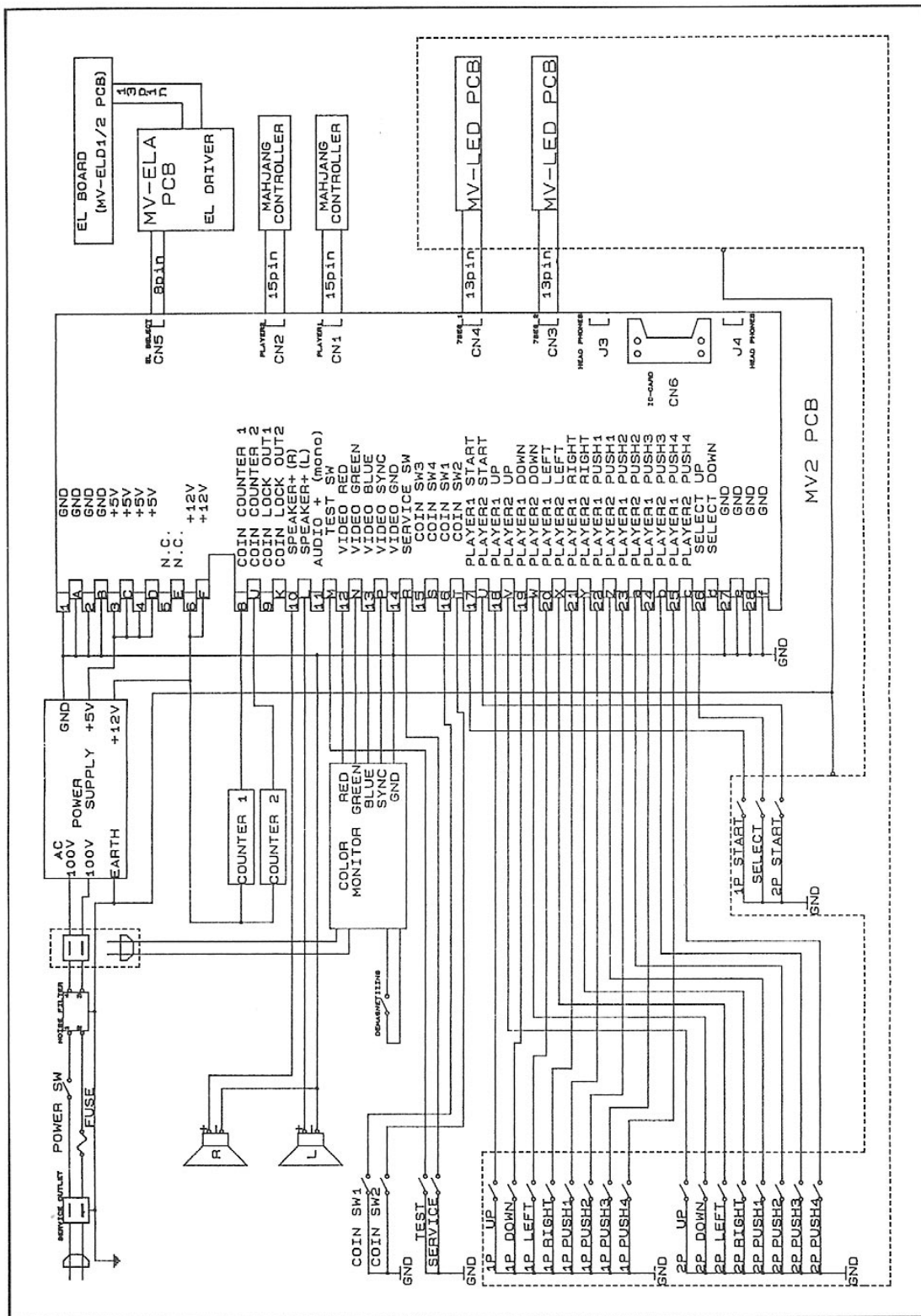

SNK CORPORATION

18-8, TOYOTSU-CHO, SUITA-SHI, OSAKA, 564, JAPAN.

TELEPHONE:(06)338-7007 FAX:(06)338-7150 TELEX:5236785 SNKCO.J

